

CUP-BB1

SINGLE / TWO STAGE API 610, AXIALLY SPLIT,
BETWEEN BEARINGS PUMPS

CLYDEUNION®
PUMP

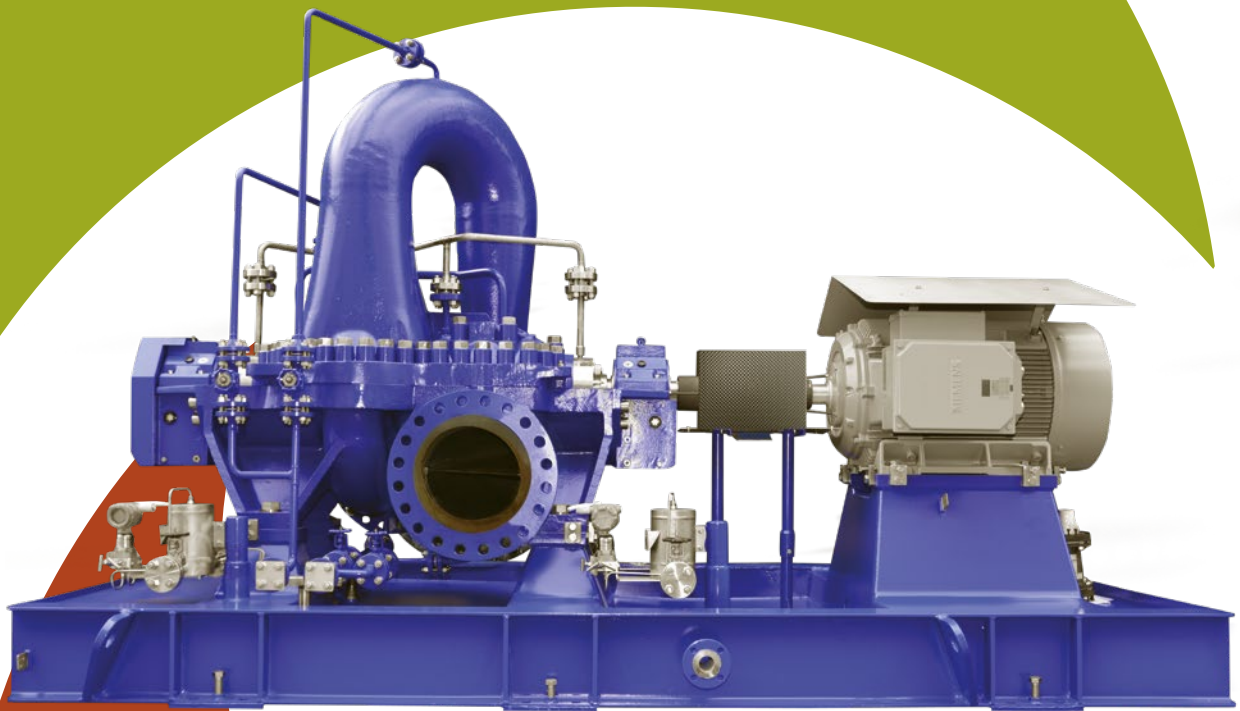

CLYDEUNION PUMPS - AN INTRODUCTION

ClydeUnion Pumps is the culmination of a long and eventful 140-year engineering legacy. In fact, most nuclear power plants currently in operation around the world employ our reactor feed pumps. We play an instrumental role in securing the vital energy and water resources that a sustainable society will rely on in the future.

Not only servicing the Nuclear market we are also a valued flow control engineering partner to the oil/gas industry - supporting upstream, downstream, transportation and offshore exploration activities. Other key areas we address include seawater desalination, waste water treatment, mining and steel production.

Combining a wealth of pump and system design knowledge, latest design, analytical and pump testing equipment, we are confident we can boost efficiency and ensure prolonged operation of our products.

The ClydeUnion Pumps brand from Celeros Flow Technology, specialises in the design and manufacture of API 610 centrifugal pumps and pumping packages and has a worldwide reputation in delivering market leading products and services to meet the technical and commercial challenges of our customers operating in the most severe duty applications.

CUP-BB1 APPLICATIONS

With extensive experience in providing complex and bespoke pumpsets, ClydeUnion Pumps cover a range of applications which include:

- Crude oil, hydrocarbons handling & petroleum products - export, pipeline + transfer duties
- Water injection & transfer
- Boiler feed booster pump
- Auxiliary services
- Pipeline
- Condensate booster
- Gas treatment
- Nuclear & conventional power
- Desalination
- Water distribution
- Utility duties for process industries
- Other process/high pressure duties

ClydeUnion Pumps engineered pumping systems for pipeline applications frequently alter throughput and product. The transfer of crude and refined products, often in remote locations, demands a wide scope of performance flexibility, high pumping reliability, and low power consumption. Our pumps are supplied to satisfy a wide range of critical pumping services for some of the most arduous applications in the most hostile environmental conditions.. Extremes of temperature, high pressure and the ability to handle volatile fluids, calls for highly engineered pumps that can perform reliably in such arduous conditions. The ClydeUnion Pumps team appreciates these needs and works closely with customers to provide the optimum solution to suit the application's life cycle needs, and is committed to providing solutions for the most complex of pumping requirements.

COMMITMENT TO QUALITY

Celeros FT is committed to quality throughout the organisation. Our Quality Management System is fully approved to ISO9001: 2015 and independently verified to comply with the latest quality standards. Celeros FT is an environmentally responsible firm.

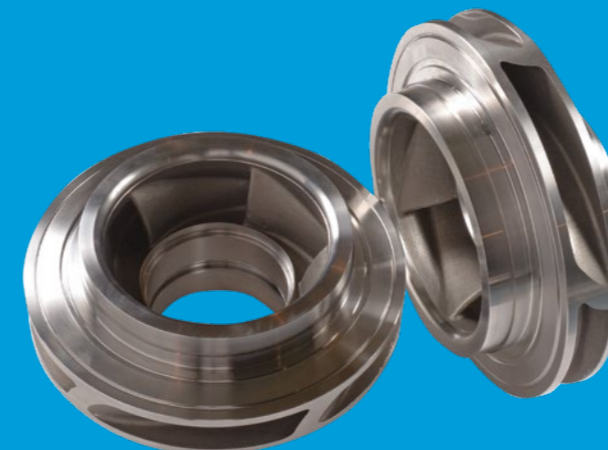

CUP-BB1 - HEAVY DUTY, AXIALLY SPLIT, SINGLE / TWO STAGE PUMPS

The ClydeUnion Pumps CUP-BB1 pump range are API 610 compliant, heavy duty, axially split single or two stage designs, engineered to maximise efficiency, provide high reliability, and offer the widest performance flexibility over the pump's life cycle, while meeting the arduous requirements of the oil industry. From short term to medium term adjustments to full hydraulic re-rates, the CUP-BB1 features are carefully selected to meet our customers' needs. Typically a combination of features such as volute insert designs, lip chipping, impeller blade and tip modifications, and varying capacity impellers, can be used to provide the highest versatility of pump operation.

PROVEN PRODUCT INTEGRITY

The CUP-BB1 encompasses proven design experience, evolving from our legacy Mather & Platt SB/MG, David Brown DB30, and Guinard Pumps DVDS, DVSS and RBMX ranges. All have an enviable history of sound engineering, with hundreds of units in operation worldwide.

ENGINEERING EXCELLENCE

ClydeUnion Pumps pride ourselves on our collaborative approach with our customers and suppliers to ensure the optimum engineering solution is achieved. Through our culture of innovation and a market facing ethos we have positioned ourselves at the leading edge of pump design. Our highly skilled staff utilise state of the art technology and analysis techniques to continuously improve and develop our pumping solutions, ensuring we deliver the most reliable, efficient and low life-cycle cost products.

OUR LEADING EXPERTISE INCLUDES:

- World class hydraulic design
- FEA stress + structural analysis
- Roto-dynamic analysis
- CFD analysis
- Noise + vibration
- Metallurgy
- Mechanical + electrical engineering
- Control + instrumentation

CUP-BB1 OPERATING PARAMETERS:

- **Capacities** - up to 15,000 m³/hr / 66,000 USgpm
- **Delivery Heads** - up to 1,000 m / 3,300 ft
- **Temperature** - up to 180 °C / 350 °F
- **Speeds** - up to 6,000 rpm
- **Flange drilling** - ANSI or BS

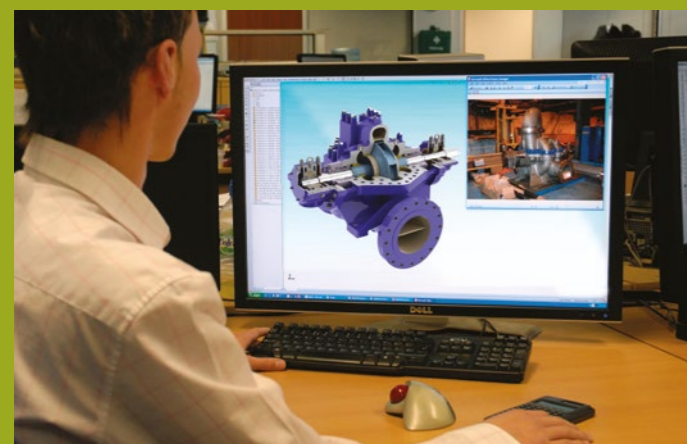

STANDARD HYDRAULIC RANGE - COVERAGE CHARTS

50HZ RANGE COVERAGE CHART

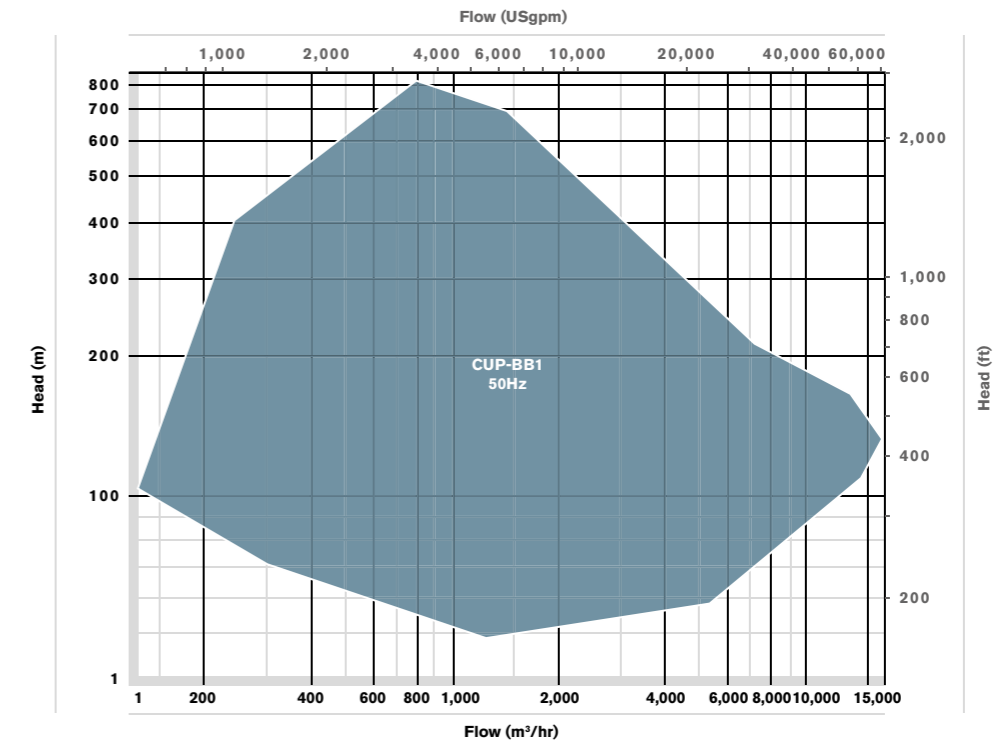

60HZ RANGE COVERAGE CHART

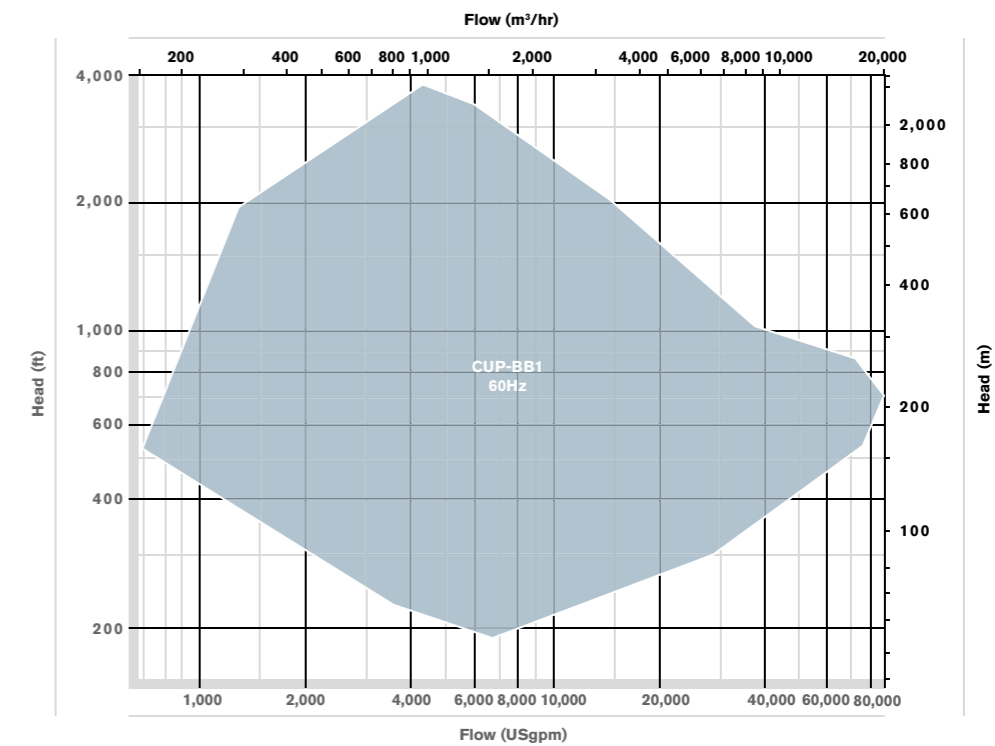

These charts cover the CUP-BB1 standard pump range. Other engineering designs exist for extreme applications

CUP-BB1 – FEATURES

1 HEAVY DUTY CASING

- High pressure casing suitable for parallel or series pumping
- Double volute design enables minimised radial loads
- Designed for full MAWP and 2 x API 610 nozzle loads
- Various mounting options available depending on fluid temperature or customer preference
- Side-side connection orientation as standard

2 ROBUST ROTOR DESIGN

- Renewable sleeves offer shaft protection against stuffing box wear and are easily replaced reducing maintenance costs
- Dynamically balanced to ISO 1940 G2.5 as standard
- Stiff shaft design ensures high critical speeds and low shaft deflection for maximum reliability, seal and bearing life

3 WEAR PARTS

- Impeller wear rings fitted as standard. Option for integral wear surfaces and hard coatings
- Materials selected to provide the optimum anti-galling properties

4 IMPELLER ARRANGEMENTS

- Precision cast for repeatable performance
- One stage double entry or various two stage arrangements with either double or single entry dependent on operating conditions
- Shrink-fitted to shaft and individually axially located
- Staggered vane impellers can be used to enhance vibration performance as necessary

5 BEARING HOUSINGS

- INPRO™ bearing isolators used as standard ensure improved sealing and bearing life
- Designed for high thermal efficiency to maximise utilisation of self-lubricated bearings

6 BEARINGS

- Generously rated, selected to suit service and customer preference
- Forced-fed lubrication as standard for hydrodynamic arrangements
- Ball or sleeve-ball bearings with self-contained lubrication options available, utilising oil rings and constant level oilers

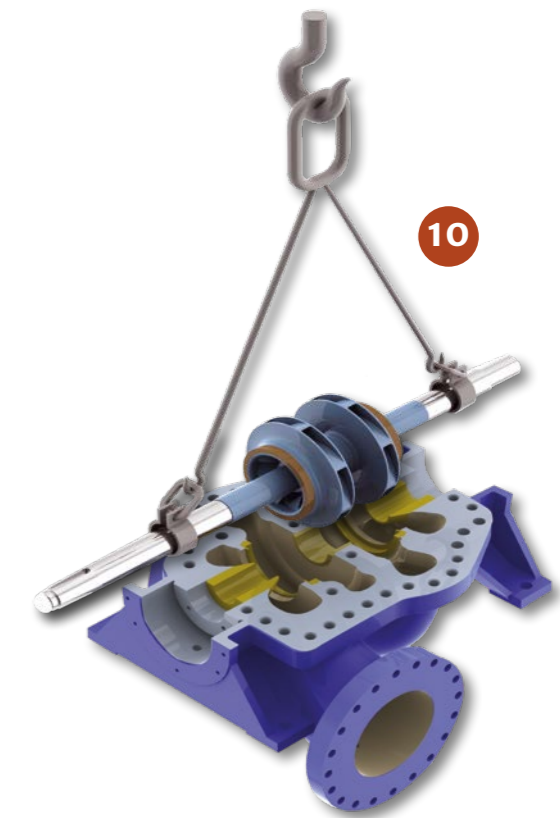
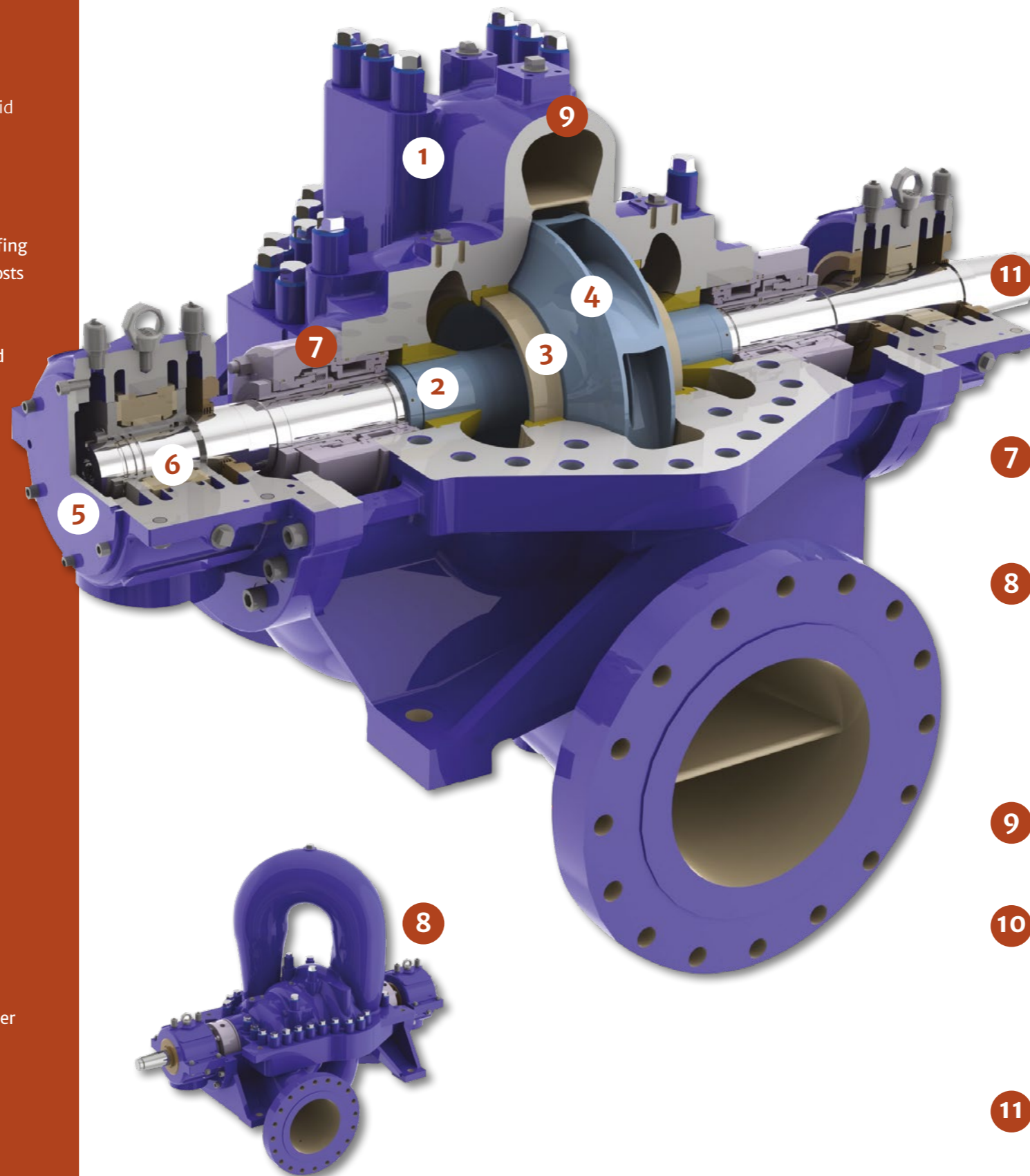

7 ADVANCED MECHANICAL SEALING (TO API 682)

- High reliability cartridge design
- Large seal chambers suitable for single or dual mechanical seals

8 ADVANCED METALLURGY OPTIONS

- All API 610 materials available
- Materials are optimised for service conditions
- Oil/hydrocarbons:
 - Carbon steel casings and shafts
 - 12-13% chrome impellers and sleeves (to API code S-6)
- Water injection:
 - Duplex/super duplex stainless steels

9 INTEGRALLY FLANGED AUXILIARY CONNECTIONS

- Eliminates weld connection and need for bracing
- Alternative options available

10 EASE OF MAINTENANCE

- The simple construction of the CUP-BB1 pump offers ease of maintenance and reliability. The axially split casing allows removal of the complete rotating element without disturbing the pipework or pump/moto alignment

11 PUMP SHAFT END

- Tapered, keyed sleeve type as standard for reliable power transmissions
- Hydraulic filament option if service requires

CUP-BB1 – COMPLETE PUMP PACKAGE SOLUTIONS

1 DRIVER OPTIONS

The CUP-BB1 can be packaged with various types of drive equipment to suit the application's needs.

Typical options include:

- 2 and 4 pole electric motors (fixed or VFD)
- Diesel/gas engine or turbine
- Further drive train options are available in order to achieve the optimal running speed
- API 677 or API 613 gearbox units
- Fluid couplings (geared or variable speed)

2 COUPLINGS

- Flexible element membrane couplings as standard for high torque drives (to API 671 when required)
- Excellent angular, lateral and axial misalignment capability
- Can be supplied with special tools for hydraulic fitting and removal of hubs

3 ADVANCED SEALING ARRANGEMENTS (TO API 682)

The CUP-BB1 pumps come with a range of single or multiple sealing arrangements used to suit various critical applications and pumped fluid properties.

Typically for non-sour service API 682 piping plans 11 and 31 utilise the process fluid as a flush within a single seal configuration

For more robust solutions multiple seal arrangements are adopted. The options here are varied but fall into two principal categories:

• Unpressurised tandem arrangements

Where product recirculation is commonly used for the in board seal with the outboard seal using a buffer fluid, from an external supply, at lower pressure than the sea chamber. Thus forming a high integrity secondary containment. Typically API 682 piping plan 52

• Pressurised double arrangements

Ensure no process leakage of gases, unstable fluids, highly toxic, abrasive, corrosive, and viscous fluids. Outboard seal holds barrier fluid from an external supply at higher pressure than the seal chamber

Both seals are lubricated by the barrier fluid. Typically API 682 secondary flush plans 53A/B/C, incorporating a variety of vessel-type reservoir sealant systems

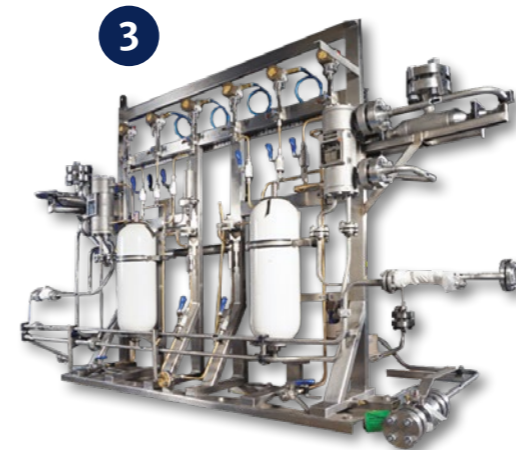
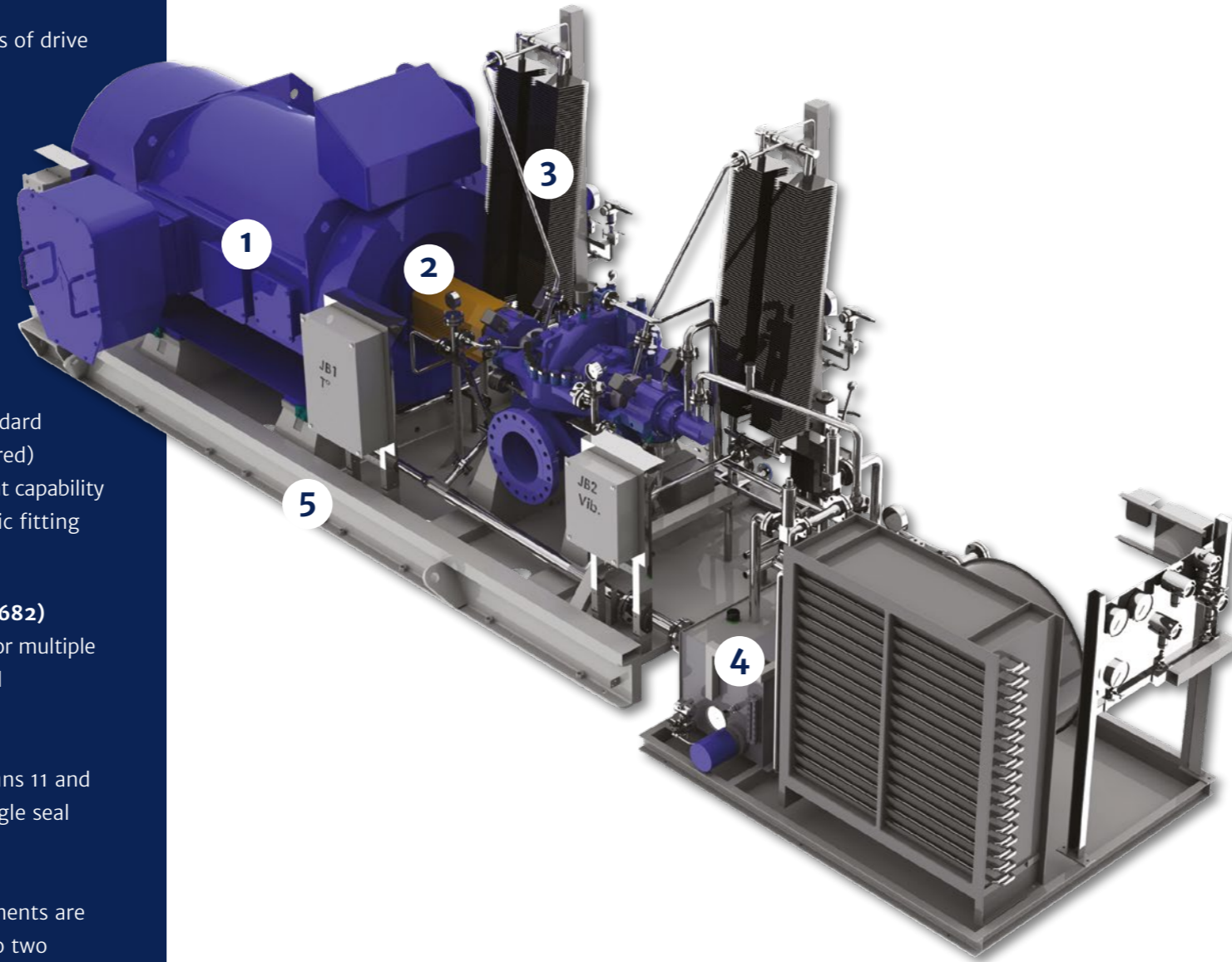

LUBRICATION SYSTEMS

- 4
- Forced lubrication systems, for use with hydrodynamic bearings, are fully compliant with api 614 (iso 10438) chapter 2 (special purpose) or chapter 3 (general purpose) to suit customer needs
 - As standard lube systems are supplied on a separately mounted console but can be 'dropped-in' to the baseplate on client request
 - For anti-friction bearing arrangements self-contained lubrication arrangements are commonly used

BASEPLATE DESIGN

- 5
- Baseplates are all welded fabrications constructed from high quality rolled steel sections to BS, ASTM or equivalent material specification
 - Designs are influenced by a number of factors, including; customer specifications, equipment set-up, and conditions prevailing at site
 - Rigid, robust designs to ensure optimum structural integrity and minimal vibration levels

PACKAGE HEALTHCARE MONITORING (TO API 670)

- 6
- The CUP-BB1 can be supplied with range monitoring equipment to enable measurement and analysis of performance data in order to aid preventative maintenance and increase availability. Our highly experienced C + I team design bespoke systems in compliance with API 670 that includes:

- Instrumentation (indicators, sensors and monitors to continuously measure the equipment temperature, vibration and pressure levels)
- Controls (switches, transmitters, PLCs, push buttons) to regulate the system operation



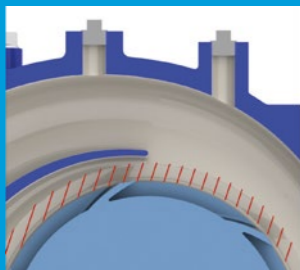

Impeller blade trimming

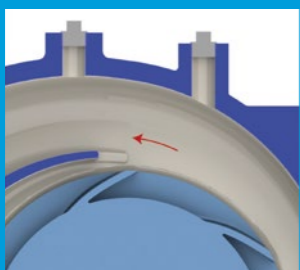

Volute lip chipping

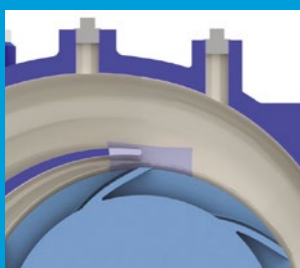

Volute insert option

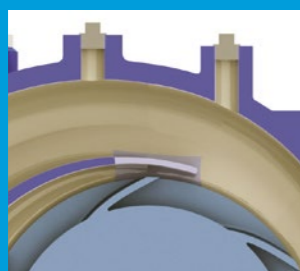

Volute insert option

OPTIONAL ARRANGEMENTS & FEATURES

FLEXIBILITY OF PERFORMANCE

Variations in flow and operating pressure mean that extreme versatility and optimised hydraulic performance are critical to our customers. The CUP-BB1 is engineered to maximise efficiency, provide high reliability, and offer the widest performance flexibility over the pumps life-cycle. From short to medium term adjustments to full hydraulic re-rates, we carefully select the CUP-BB1 pumps features specific to your needs. Typically a combination of the following can be used:

RUNNING CLEARANCES

- Reduced running clearances are used to assist in maintaining a very high level of efficiency – close to 90%. The option of PEEK, or other non-metallic type wear rings can enable even tighter clearances, further enhancing efficiency.

IMPELLER ADJUSTMENTS

- The CUP-BB1 can offer low to high capacity impeller options within the same pump frame that are interchangeable and conveniently modified at site
- Impeller blade tips can be trimmed or increased to vary the generated head
- Velocity leaving the impeller can be adjusted via under-filing (removal of metal) from the non-working side of the impeller blade

VOLUTE ADJUSTMENTS

- Volute lip modification – adjusting the volute throat velocity (entering) by cutting back the stationary volute lip or lips to a predetermined size (on both single and double volutes) to increase flow
- Volute inserts – use of removable insert pieces within the volute to modify (reduce or increase) the internal fluid passages and hence convert to higher or lower flow capacities as required

TYPICAL PERFORMANCE FLEXIBILITY

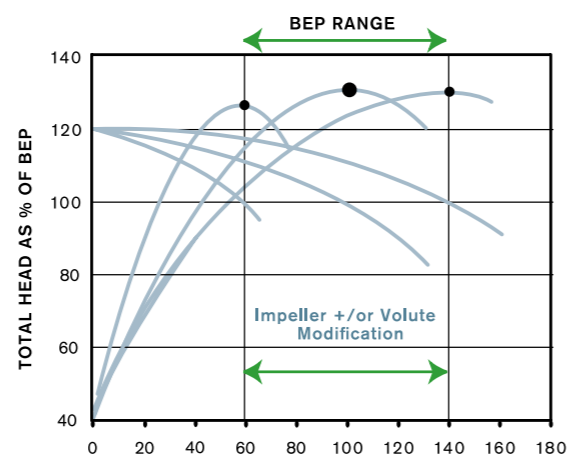

GLOBAL AFTERMARKET CAPABILITY BEST IN SERVICE & RESPONSE

Our customer focused aftermarket organisation is positioned to provide comprehensive care for our varied and diverse product lines. Heritage and obsolete products benefit from the same level of attention and expertise ensuring that reliability and availability is maximised irrespective of a pump's length of service.

GENUINE HIGH QUALITY

Original or upgraded specification spare parts, coupled with full engineering design capability, enables longevity of reliable operation. Highly skilled and experienced service engineers ensure accuracy in build and optimised performance. Optimised performance from local service facilities worldwide.

SERVICE SOLUTIONS

Celeros FT is committed to supporting our installed base wherever it may be. Depending on your location we will provide either direct service support or support via our local authorised service partners. Whichever option is provided, you can be assured of the best attention from fully qualified and experienced engineers.

- Upgrades & re-rates
- Service & overhaul
- Installation & commissioning
- Technical support
- Inventory management
- 3rd party equipment



Parts & maintenance:
Any brand, any material, anytime.
Heritage products, upgrades & improvements

| SPEED
| EXCELLENCE
| PARTNERSHIP

CLYDEUNION®
PUMP

EUROPE

Annecy P: +(33) 45 005 5600 E: cu.annecy@celerosft.com
Glasgow P: +(44) 141 637 7141 E: cu.glasgow@celerosft.com

AMERICAS

Baton Rouge, LA P: +(1) 225 775 2660 E: cu.batonrouge@celerosft.com
Battle Creek, MI P: +(1) 269 966 4600 E: cu.battlecreek@celerosft.com
Burlington, ON P: +(1) 905 315 3800 E: cu.burlington@celerosft.com
Calgary, AB P: +(1) 403 236 8725 E: cu.calgary@celerosft.com
Los Angeles, CA P: +(1) 562 622 2380 E: cu.downey@celerosft.com
Houston, TX P: +(1) 281 372 5040 E: cu.houston@celerosft.com

ASIA

Beijing P: +(86) 10 5926-7000 E: cu.beijing@celerosft.com
New Delhi P: +(91) 120 4640 400 E: cu.newdelhi@celerosft.com
Shanghai P: +(86) 21 2208 5888 E: cu.shanghai@celerosft.com
Singapore P: +(65) 62 76 7117 E: cu.singapore@celerosft.com

MIDDLE EAST

Abu Dhabi P: + (971) 2 408 1900 E: abudhabi.sc@celerosft.com
Dubai P: +971 (0)4-5289555 E: abudhabi.sc@celerosft.com

Celeros Flow Technology reserves the right to incorporate our latest design and material changes without notice or obligation. Design features, materials of construction, and dimensional data, as described in this bulletin, are provided for your information only and should not be relied upon unless confirmed in writing. Please contact your local sales representative for product availability in your region. For more information, visit www.celerosft.com.

CUP_BB1_220_PB_A4_Version 09/2023 Issued 09/2023 COPYRIGHT © 2023 CELEROS, Inc.