

PERFORMANCE  
MADE  
SMARTER

# Safety manual

## 5437 / 6437

### 2-wire HART temperature transmitter

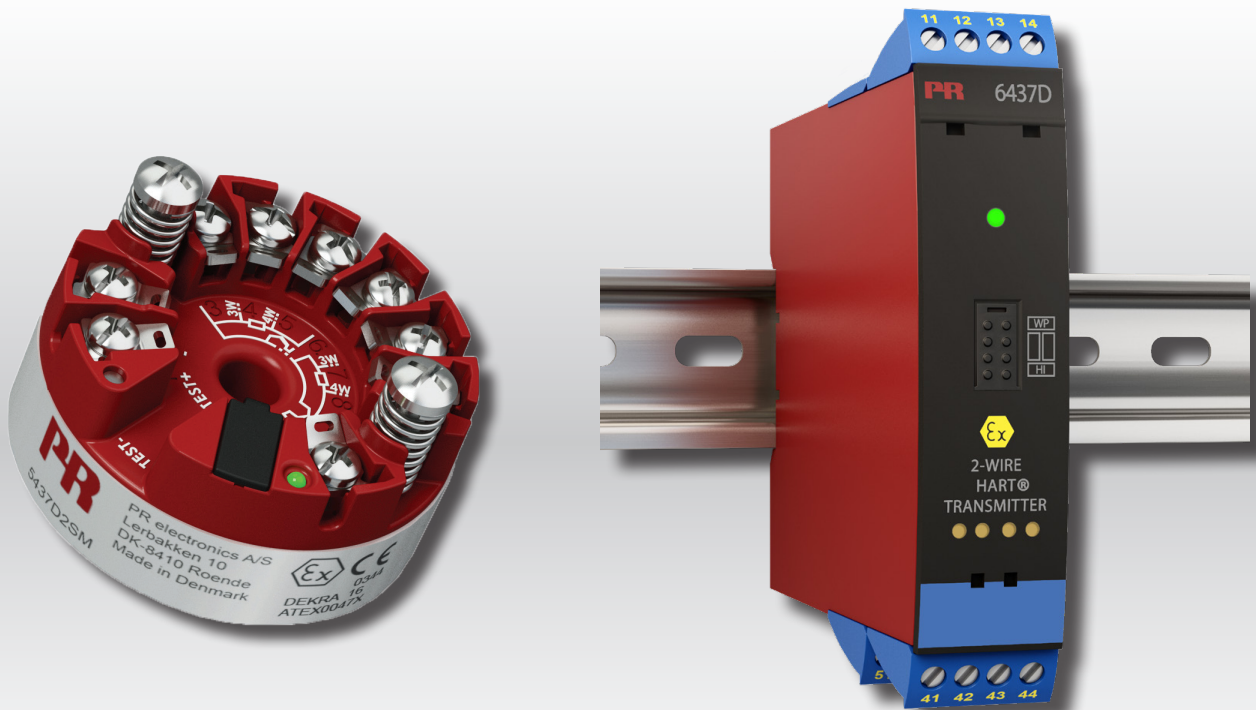

TEMPERATURE | I.S. INTERFACES | COMMUNICATION INTERFACES | MULTIFUNCTIONAL | ISOLATION | DISPLAY

Version No. V4R0

**PR**  
electronics

# 6 Product Pillars

## *to meet your every need*

### Individually outstanding, unrivalled in combination

With our innovative, patented technologies, we make signal conditioning smarter and simpler. Our portfolio is composed of six product areas, where we offer a wide range of analog and digital devices covering over a thousand applications in industrial and factory automation. All our products comply with or surpass the highest industry standards, ensuring reliability in even the harshest of environments and have a 5-year warranty for greater peace of mind.



Temperature

Our range of temperature transmitters and sensors provides the highest level of signal integrity from the measurement point to your control system. You can convert industrial process temperature signals to analog, bus or digital communications using a highly reliable point-to-point solution with a fast response time, automatic self-calibration, sensor error detection, low drift, and top EMC performance in any environment.



I.S. Interface

We deliver the safest signals by validating our products against the toughest safety standards. Through our commitment to innovation, we have made pioneering achievements in developing I.S. interfaces with SIL 2 Full Assessment that are both efficient and cost-effective. Our comprehensive range of analog and digital intrinsically safe isolation barriers offers multifunctional inputs and outputs, making PR an easy-to-implement site standard. Our backplanes further simplify large installations and provide seamless integration to standard DCS systems.



Communication

We provide inexpensive, easy-to-use, future-ready communication interfaces that can access your PR installed base of products. All the interfaces are detachable, have a built-in display for readout of process values and diagnostics, and can be configured via push-buttons. Product specific functionality includes communication via Modbus and Bluetooth and remote access using our PR Process Supervisor (PPS) application, available for iOS and Android.



Multifunction

Our unique range of single devices covering multiple applications is easily deployable as your site standard. Having one variant that applies to a broad range of applications can reduce your installation time and training, and greatly simplify spare parts management at your facilities. Our devices are designed for long-term signal accuracy, low power consumption, immunity to electrical noise and simple programming.



Isolation

Our compact, fast, high-quality 6 mm isolators are based on microprocessor technology to provide exceptional performance and EMC-immunity for dedicated applications at a very low total cost of ownership. They can be stacked both vertically and horizontally with no air gap separation between units required.



Display

Our display range is characterized by its flexibility and stability. The devices meet nearly every demand for display readout of process signals, and have universal input and power supply capabilities. They provide a real-time measurement of your process value no matter the industry, and are engineered to provide a user-friendly and reliable relay of information, even in demanding environments.

# Safety Manual

## 2-wire HART temperature transmitter 5435/5437/6437

**This safety manual is valid for the following product versions:**

**5435: 01.00.00 – 01.99.99**

**5437: 01.00.00 – 01.99.99**

**6437: 01.00.00 – 01.99.99**

# 1 Table of contents

- 1 Table of contents ..... 2
- 2 Observed standards ..... 4
- 3 Acronyms and abbreviations ..... 4
- 4 Purpose of the product ..... 4
- 5 Assumptions and restrictions for use of the product ..... 5
  - 5.1 Basic safety specifications ..... 5
  - 5.2 Useful lifetime ..... 5
  - 5.3 Safety accuracy ..... 5
    - 5.3.1 Minimum span ..... 5
    - 5.3.2 Range limitations ..... 5
  - 5.4 Associated equipment ..... 5
    - 5.4.1 RTD, or linear resistance sensor wiring ..... 5
    - 5.4.2 Potentiometer sensor wiring ..... 6
    - 5.4.3 Sensor short circuit errors ..... 6
    - 5.4.4 Extension port ..... 6
    - 5.4.5 Process calibration (input trimming) ..... 6
    - 5.4.6 Analog output ..... 6
  - 5.5 Failure rates ..... 6
  - 5.6 Safe parameterization ..... 7
  - 5.7 HW Jumper ..... 8
  - 5.8 Installation in hazardous areas ..... 8
  - 5.9 FMEDA Report ..... 8
- 6 Device states ..... 9
- 7 Device modes ..... 9
- 8 Functional specification of the safety function ..... 9
  - 8.1 Single ..... 9
  - 8.2 Dual ..... 9
  - 8.3 Redundant (Sensor Drift detection) ..... 10
- 9 Functional specification of the non-safety functions ..... 10
- 10 Safety parameters ..... 10
- 11 Hardware and software configuration ..... 11
- 12 Failure category ..... 11
- 13 Periodic proof test procedure ..... 11
- 14 Procedures to repair or replace the product ..... 12
- 15 Maintenance ..... 12
- 16 Configuration of the transmitter ..... 12
  - 16.1 Password protection ..... 12
    - 16.1.1 Changing password ..... 12
    - 16.1.2 Enabling password protection ..... 12
    - 16.1.3 Disabling password protection ..... 12
  - 16.2 Process calibration (input trimming) ..... 12

|        |  |    |
|--------|--|----|
| 16.2.1 | Lower trim point (offset/taring).....            | 13 |
| 16.2.2 | Lower and upper trim point.....                  | 13 |
| 16.2.3 | Restore factory calibration.....                 | 13 |
| 16.3   | Limit Check.....                                 | 13 |
| 16.3.1 | Input.....                                       | 13 |
| 16.3.2 | Output.....                                      | 14 |
| 16.4   | Backup functionality.....                        | 14 |
| 17     | Safe parameterization - user responsibility..... | 14 |
| 17.1   | Safety-related configuration parameters.....     | 14 |
| 17.1.1 | Input 1 parameters.....                          | 14 |
| 17.1.2 | Input 2 parameters.....                          | 18 |
| 17.1.3 | External CJC parameters.....                     | 19 |
| 17.1.4 | PV parameters.....                               | 19 |
| 17.1.5 | Analog Output parameters.....                    | 20 |
| 17.1.6 | HART parameters.....                             | 22 |
| 17.1.7 | Option Parameters.....                           | 23 |
| 17.2   | Entering SIL mode.....                           | 23 |
| 17.3   | Validating all safety related Parameters.....    | 23 |
| 17.4   | Exiting SIL mode.....                            | 23 |
| 17.5   | Functional test.....                             | 24 |
| 18     | Fault reaction and restart condition.....        | 24 |
| 18.1   | Application specific faults.....                 | 24 |
| 18.2   | Device faults.....                               | 24 |
| 19     | Installation.....                                | 24 |
| 19.1   | Connections diagram 5435/5437.....               | 25 |
| 19.2   | Connections diagram 6437 single channel.....     | 26 |
| 19.3   | Connections diagram 6437 dual channel.....       | 27 |

## 2 Observed standards

| Standard           | Description   |
|--------------------|---|
| IEC 61508          | Functional Safety of electrical / electronic / programmable electronic safety-related systems     |
| IEC 61508-2:2010   | Part 2: Requirements for electrical / electronic / programmable electronic safety-related systems |
| IEC 61508-3:2010   | Part 3: Software requirements   |
| IEC 61326-3-1:2008 | Immunity requirements for safety-related systems  |

## 3 Acronyms and abbreviations

| Acronym / Abbreviation | Designation                                    | Description   |
|------------------------|--|---|
| Element                |  | Term defined by IEC 61508 as “part of a subsystem comprising a single component or any group of components that performs one or more element safety functions”  |
| PFD                    | Probability of Failure on Demand               | This is the likelihood of dangerous safety function failures occurring on demand.   |
| PFH                    | Probability of dangerous Failure per Hour      | The term “Probability” is misleading, as IEC 61508 defines a Rate.  |
| SFF                    | Safe Failure Fraction                          | Safe Failure Fraction summarises the fraction of failures which lead to a safe state and the fraction of failures which will be detected by diagnostic measures and lead to a defined safety action.      |
| SIF                    | Safety Integrity Function                      | Function that provides fault detection (to ensure the necessary safety integrity for the safety functions)  |
| SIL                    | Safety Integrity Level                         | The international standard IEC 61508 specifies four discrete safety integrity levels (SIL 1 to SIL 4). Each level corresponds to a specific probability range regarding the failure of a safety function. |
| FMEDA                  | Failure Modes, Effects and Diagnostic Analysis | From the FMEDA, failure rates are determined and consequently the SFF, PFD and PFH figures can be calculated, and thereby the achieved SIL.   |

## 4 Purpose of the product

2-wire HART temperature transmitter for temperature measurement with TC and RTD sensors. True dual input with high density 7 terminal design allows measurement of two 4-wire RTDs. Sensor redundancy allows automatic switch to secondary sensor in the event of primary sensor failure and sensor drift detection issues an alert when sensor differential exceeds predefined limits. The device has been designed, developed and produced for use in SIL 2/3 applications according to the requirements of IEC 61508 : 2010

The following product variants are considered in this Safety Manual:

| Description:  | Suffix:                 |
|---|-------------------------|
| Head mounted 2w programmable temperature transmitters     | 5435x1Sx <sup>1</sup>   |
|   | 5437x1Sx <sup>1</sup>   |
|   | 5437x2Sx <sup>1</sup>   |
| DIN rail mounted 2w programmable temperature transmitters | 6437x1Sx <sup>1</sup>   |
|   | 6437x2Sx <sup>1</sup>   |
|   | 6437x3Sx <sup>1,2</sup> |

(e.g. a 5437D2S is a 5437 unit with intrinsic safety, two sensor inputs and SIL approval but no Marine approval).

Note <sup>1</sup>: The “x” on first and fourth position after the main product name indicates various approvals which have no impact on the safety aspects of the device.

Note <sup>2</sup>: The 6437 DIN rail variant is available in the “3” version where two independent single input units are mounted in a DIN rail housing. This means that a 6437x3Sx unit has two independent channels, each with one sensor input and one loop output, and each with its own unique HART ID.

## 5 Assumptions and restrictions for use of the product

### 5.1 Basic safety specifications

|  |   |
|--|---|
| Ambient operating temperature range.....                       | -40...+80°C                               |
| Storage temperature range .....                                | -50...+85°C                               |
| Supply voltage, non-Ex .....                                   | 7.5*...48** VDC (at terminals)            |
| Supply voltage, Ex ia .....                                    | 7.5*...30** VDC (at terminals)            |
| Additional min. supply voltage when using test terminals ..... | 0.8 V                                     |
| Max. internal power dissipation .....                          | ≤ 850 mW                                  |
| Min. load resistance at > 37 V supply .....                    | (Supply voltage – 37) / 23 mA             |
| Mounting area.....   | Zone 0, 1, 2 / Division 2<br>or safe area |
| Mounting environment.....                                      | Pollution degree 2 or better              |
| Max. wire size.....  | 1 x 1.5 mm <sup>2</sup> stranded wire     |
| Screw terminal torque 5435/5437 .....                          | 0.4 Nm                                    |
| Screw terminal torque 6437 .....                               | 0.5 Nm                                    |

\* Note: Observe that the minimum Supply Voltage must be as measured at the terminals of the 5435/5437/6437, i.e. all external drops must be considered.

\*\* Note: Make sure to protect the device from over-voltages by using a suitable power supply or by installing overvoltage protecting devices.

### 5.2 Useful lifetime

The established failure rates of electrical components apply within the useful lifetime as per IEC 61508-2:2010 section 7.4.9.5 note 3, or as determined by users own statistics.

The device contains no components that are especially sensitive to environmental conditions, neither does it contain any unmanaged memory components with suspected retention times.

### 5.3 Safety accuracy

The analog output corresponds to the applied input within the safety accuracy.

Safety accuracy..... ±2%

#### 5.3.1 Minimum span

The selected range (*PV Upper Range - PV Lower Range*) shall be larger or equal to the values below:

| Configured input type                     | Minimum span | Unit |
|---|--------------|------|
| Pt100-Pt10000, Ni100-Ni1000, Cu100-Cu1000 | 25           | °C   |
| Pt50, Ni50, Cu50                          | 50           | °C   |
| Pt20, Ni20, Cu20                          | 125          | °C   |
| Pt10, Ni10, Cu10                          | 250          | °C   |
| Cu5                                       | 500          | °C   |
| TC: E, J, K, L, N, T, U                   | 100          | °C   |
| TC: Lr, R, S, W3, W5, B                   | 400          | °C   |
| Voltage -20...100 mV                      | 1.3          | mV   |
| Voltage -0.1...1.7 V                      | 0.12         | V    |
| Voltage ±0,8 V                            | 0.12         | V    |
| Linear Ohms 0...400 Ohm                   | 10           | Ohm  |
| Linear Ohms 0...100 kOhm                  | 1            | kOhm |
| Potentiometer                             | 10           | %    |

#### 5.3.2 Range limitations

For SIL applications, TC input type B shall not be used below +400°C since the accuracy will be lower than the specified safety accuracy.

## 5.4 Associated equipment

### 5.4.1 RTD, or linear resistance sensor wiring

If *Input 1 Number of Wires / Input 2 Number of Wires* is configured to 2 or 3, and *Input Type 1 / Input Type 2* is RTD, Ohm or kOhm, the end user must ensure that the applied sensor wiring does not introduce failures exceeding the requirements for the safety application.

#### 5.4.2 Potentiometer sensor wiring

If *Number of Wires* is configured to 3 or 4, and *Input Type* is Potentiometer, the end user must ensure that the applied sensor wiring does not introduce failures exceeding the requirements for the safety application.

#### 5.4.3 Sensor short circuit errors

Detection of short-circuited sensors, or short-circuited sensor wires, is ignored for both Input 1 and Input 2 if either of their *Input Types* is configured as listed below:

- Ohms or kOhms
- Pt50 or Ptx and RTD Factor < 100
- Nix and RTD Factor < 50
- Cu10, Cu50 or Cux and Sensor Custom RTD Resistance < 100
- Potentiometer and *Input 1 Upper Limit* (potentiometer size) < 18 Ohm

For Potentiometer there is no short circuit detection on potentiometer arm.

Detection of short-circuited sensor or short-circuited sensor wires is ignored for Input 1 or Input 2 if its *Input Type* is configured as listed below:

- Micro-Volts, Milli-Volts or Volts (bipolar or unipolar)
- Any TC type (detection of shorted External CJC sensor is NOT ignored)

If any of these input types shall be used in a Safety Application, the user must ensure that the applied sensors, including wiring, have failure rates that qualify them, without detection of short-circuited sensors or wires.

#### 5.4.4 Extension port

Only equipment designed specifically for connection to the extension port of 5435/5437/6437 may be connected. This equipment will specify the applied maximum operating voltage drop;  $V_{EXT}$ .

The user must make sure that the supply voltage, minus any drops for external measurement or communication resistances, and minus the applied maximum drop for the equipment attached to the extension port, will be higher than the minimum specified supply voltage:

$$V_{SUPPLY} > 7.5 + V_{EXT} + V_{DROP}$$

#### 5.4.5 Process calibration (input trimming)

If a process calibration on either Input 1 or Input 2 has been carried out before entering SIL-mode operation, it is mandatory that the accuracy of the device (and sensor, if applicable) is tested by the end user after SIL-mode is entered, in addition to the normal functional test. Refer to "Section 16.2 Process calibration (input trimming)" on page 12.

#### 5.4.6 Analog output

The connected safety PLC shall be able to detect and handle the fault indications on the analog output of the 5435/5437/6437 transmitter by having a NAMUR NE43-compliant current input. The safety PLC must be able to detect and react to error signals according to NE43 within 1 second. If Output Limit Check is disabled (see "Section 16.3.2") in SIL mode, the connected Safety PLC shall also be able to detect and react to a current in the extended range acc. to NAMUR NE43, within 1 second. The limits for the detection shall be <20.5 mA and >3.8 mA.

The Loop Link communication interface, PR5909, is not supported in SIL mode and shall only be connected when the device is not operating in SIL mode. The 5909 Loop Link interface cannot be used to enter or exit SIL mode.

### 5.5 Failure rates

The basic failure rates from the Siemens standard SN 29500 are used as the failure rate database.

Failure rates are constant, wear-out mechanisms are not included.

External power supply failure rates are not included.



## 5.6 Safe parameterization

The user is responsible for verifying the correctness of the configuration parameters. (See "Section 17 Safe parameterization - user responsibility" on page 14).

After parametrization it is not possible to simulate any measurements or the analog output.

The following restrictions applies to the configuration parameters:

| Function / Parameter             | SIL Requirements  |
|----------------------------------|---|
| Sensor 1/2 Input Type            | Cannot be "Callendar Van Dusen" or "Custom"   |
| Output Range 0%                  | Must be 4.0 mA  |
| Output Range 100%                | Must be 20.0 mA   |
| Limit Check Configuration        | Must be "Limit Check Enabled on Input Range" or "Limit Check Enabled on Input and Output Range" |
| Output Limit - Error Value       | Must be $\leq 3.6$ mA or $\geq 21.0$ mA (if enabled on output)                                  |
| Output Lower Limit               | Must be 3.8 mA  |
| Output Upper Limit               | Must be 20.5 mA   |
| Sensor Error Action              | Must be set to "Broken and Shorted"   |
| Broken Sensor - Error Value      | Must be $\leq 3.6$ mA or $\geq 21.0$ mA   |
| Shorted Sensor - Error Value     | Must be $\leq 3.6$ mA or $\geq 21.0$ mA   |
| Sensor Drift - Error Value       | Must be $\leq 3.6$ mA or $\geq 21.0$ mA (if enabled)  |
| Input Limits - Error Value       | Must be $\leq 3.6$ mA or $\geq 21.0$ mA   |
| Analog Output Calibration Gain   | Must be 1.0 (calibration of output current is not allowed)                                      |
| Analog Output Calibration Offset | Must be 0.0 (calibration of output current is not allowed)                                      |
| Loop Current Mode                | Must be "Enabled" (HART 7 only)   |
| HART Polling Address             | Must be 0 (HART 5 only)   |
| Write Protection                 | Must be "The configuration is protected by Password"  |

For detailed description of the configuration parameters, see sections 16 and 17.

## 5.7 HW Jumper

For SIL applications, any detected device error must force the analog output to a value below 3.6 mA. I.e. in SIL mode the HW jumper from P7-P8 may NOT be inserted.

The HW write protection by inserting a jumper from P1-P2 can be applied as an extra write protection, after configuration and after SIL mode is entered.

Note: for SIL applications, the Password Write protection must be applied. (See "Section 17 Safe parameterization - user responsibility" on page 14)

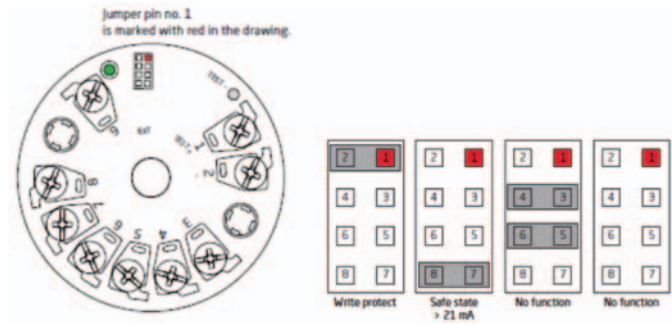

Figure 1 Placement of HW Jumper 5435/5437

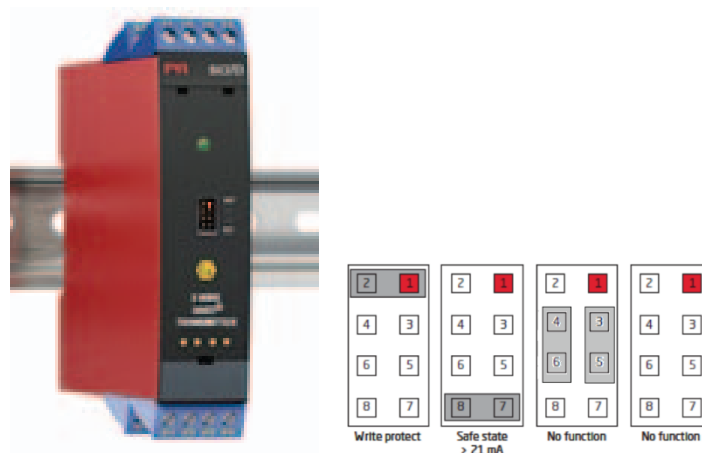

Figure 2 Placement of HW Jumper 6437 single channel

The HW jumper is not available on 6437 dual channel (Corresponds to all jumpers in "No function" position).

## 5.8 Installation in hazardous areas

The IECEx Installation drawing, ATEX Installation drawing and FM Installation drawing shall be followed if the products are installed in hazardous areas.

## 5.9 FMEDA Reports

The FMEDA reports are issued by exida.

For 5435/5437: "FMEDA report for Temperature Transmitters PR5435/PR5437 with 4-20 mA output, Version V1 Revision R5"

For 6437: "FMEDA report for Temperature Transmitter PR6437 with 4-20 mA output, Version V1 Revision R0"

The reports can be downloaded from the PR website [www.prelectronics.com](http://www.prelectronics.com) and are easily found by entering the product name, e.g. "5437", in the search field. From the results, open the corresponding link, e.g. "2-wire HART 7 temperature transmitter 5437A", and browse through the links on the right-hand side to the FMEDA report.

## 6 Device states

The states of the device are defined as shown in the table below, specific failure rates for each mode:

| Device state                  | Description  |
|-------------------------------|--|
| Normal operation (4-20 mA)    | The safe current output is within the defined safety accuracy range.   |
| Detected failure (Safe state) | The safe current output is $\leq 3.6$ mA (defined as a failure signal) or $\geq 21$ mA.  |
| Dangerous state               | Dangerous state applies when current output is within the range 4...20 mA and deviates from the correct process value by more than the defined safety accuracy range for longer than 60 seconds. |

## 7 Device modes

The device can operate in various modes:

- Normal Mode: Non-Safety Operation is for use in non-safety related applications.
- SIL Mode: Safety Operation and Safety Error are for use in safety related applications.

The following table describes the different Device modes:

| Mode   | Description  | SIL Status | Current output value                         | Safe current output |
|--|--|------------|--|---------------------|
| Reset/Startup  | The device has just been started up or reset, and is determining the next mode.<br>The device will leave this mode after maximum 2 seconds.  | INIT       | Failure signal $\leq 3.5$ mA                 | Yes                 |
| Non-Safety Operation (Normal Mode)                             | The device is operating without user-validated safe parameterization.<br>The device may operate with factory default configuration, or with a specific ordered configuration. This mode is valid for use in non-safety related applications only.<br>The user shall assign safety related parameters to the device in this mode. | OPEN       | Operation signal (4 to 20 mA)                | No                  |
| Safety Validation mode (Transfer from Normal mode to SIL Mode) | The device is in the process of validating the entered safety parameters and the safety function. See "Section 17 Safe parameterization - user responsibility" on page 12 for more information. The device will leave this mode when the user either accepts or rejects the safety parameterization.                             | INIT       | Failure signal $\leq 3.5$ mA                 | Yes                 |
| Safety Operation (SIL Mode)                                    | The device operates in safe mode and delivers safe measurement output on the current output. When operating in this mode, the device is valid for safety related applications.   | LOCK       | Operation signal (4 to 20 mA)                | Yes                 |
| Safe Parametrization failed                                    | The device has failed the validation of the current configuration for safety operation.  | FAIL       | Failure signal $\leq 3.5$ mA                 | Yes                 |
| Safety Error (SIL Mode)  | The device enters this mode if the system detects a safety related error in Safety Operation mode.<br>The possible errors are listed in the error list of the device.  | LOCK       | Failure signal $\leq 3.6$ mA or $\geq 21$ mA | Yes                 |

## 8 Functional specification of the safety function

All safety functions relate exclusively to the analog 4...20 mA current output signal.

Conversion of voltage signals, potentiometer, linear resistance, RTD sensor signals or thermocouple sensor signals in hazardous areas to the output signal within specified accuracy.

For RTD, potentiometer and linear resistance inputs, cable resistances of up to 50 Ohm per wire can be compensated if 3- or 4-wire connection is configured (4- or 5-wire for potentiometer).

For thermocouple sensors, cold junction temperature errors can be compensated, either by an internally mounted temperature sensor, by an external temperature sensor or by a fixed temperature value. The selection of CJC measurement must be done and verified by the end user.

The 5435/5437/6437 will detect if any of the applied sensors or their connection wires are short-circuited or broken with the restrictions given in "Section 5.4.3 Sensor short circuit errors" on page 6.

One or two inputs can be measured in combinations. The failure rates are determined by the FMEDA for the following configurations:

### 8.1 Single

Only one input is measured, the signal is evaluated to control the current output. For 5437A2/5437D2 and 6437A2/6437D2 one of the inputs is not used.

### 8.2 Dual

Two (both) inputs are measured. The evaluation of the signals includes a mathematical combination such as difference or average of the two signals. The result of the evaluation controls the current output.

Only available with dual input units, 5437A2/5437D2 and 6437A2/6437D2.

### 8.3 Redundant (Sensor Drift detection)

By setting “Sensor Drift Action” parameter to “Error”, as described in 17.1.5, two (both) inputs are measured and evaluated. The two results are compared by the transmitter and the current output is set to the safe state if the difference between the evaluated values exceeds a defined (configured) limit, or if a sensor error is detected on any of the inputs.

The function is only available with dual input units, 5437A2/5437D2 and 6437A2/6437D2.

## 9 Functional specification of the non-safety functions

LED outputs and Process Values delivered using HART or Extension Port communication are not suitable for use in any Safety Instrumented Function.

## 10 Safety parameters

All figures for probability of failures are specified in the FMEDA report issued by exida, see chapter 5.9.

| Common Safety Parameters  |  |
|---|--|
| Demand response time<br>(if “Damping” is configured to 0.0 sec.)  | < 75 ms  |
| Demand mode   | Low, High or Continuous  |
| Mean Time To Repair (MTTR)  | 24 hours   |
| Fault detection and reaction time   | 60 seconds   |
| Process safety time   | 120 seconds  |
| Systematic capability   | SC 3   |
| Component Type (Complexity)   | B  |
| Description of the “Safe State”, analog output  | Output ≤ 3.6 mA or<br>Output ≥ 21 mA   |
| Proof test interval   | Periodic proof testing is normally not required within the useful lifetime for obtaining required PFD <sub>AVG</sub> figures |
| SIL 2 capability  |  |
| Hardware Fault Tolerance (HFT)  | 0  |
| Operation   | Single transmitter operation<br>1oo1 (see Figure 3)  |
| SIL 3 capability  |  |
| Due to the systematic capability of the transmitter for SC 3, it is possible to use the instrument in homogenous redundant systems up to SIL 3. |  |
| Hardware Fault Tolerance (HFT)  | 1  |
| Operation<br>The redundancy requires that the Safety PLC compares the two inputs and reacts on inconsistency                                    | Two transmitter/two channel<br>operation 1oo2<br>(see Figure 5 and 6)  |

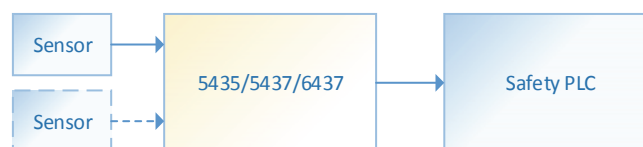

Figure 3 Single transmitter 1oo1 operation

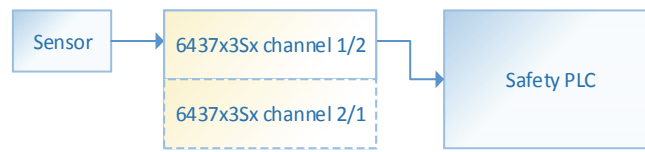

Figure 4 6437 dual channel, one channel used for 1oo1 operation

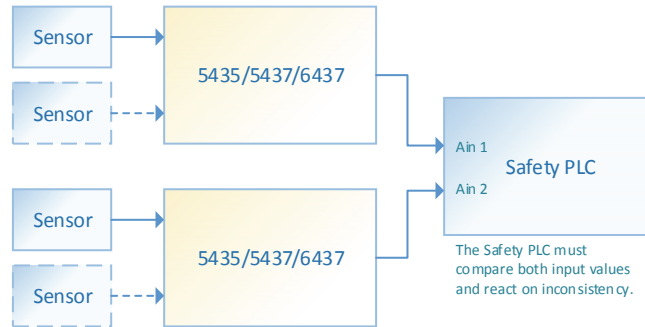

Figure 5 Two transmitter 1oo2 operation

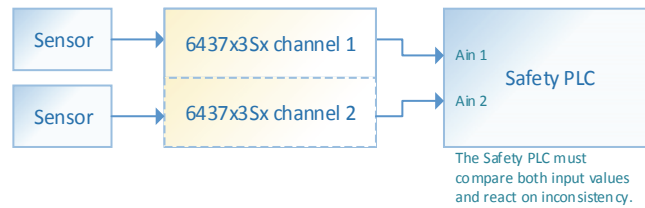

Figure 6 6437 Dual channel 1oo2 operation

## 11 Hardware and software configuration

All configurations of software and hardware versions are fixed from factory, and cannot be changed by end-user or reseller. This manual only covers products labelled with the product version (or range of versions) specified on the front page.

## 12 Failure category

All failure rates and failure categories are specified in the FMEDA report issued by exida, see chapter 5.9.

## 13 Periodic proof test procedure

This test will detect approximately 90% of possible “du” (dangerous undetected) failures in the device. See FMEDA report issued by exida, specified in chapter 5.9

The proof test is equivalent to the functional test so this procedure shall be followed when a functional test must be carried out, as described in “section 17.5 Functional test”.

| Step | Action  |
|------|---|
| 1    | Bypass the safety PLC or take other appropriate action to avoid a false trip/measurement.   |
| 2    | Disconnect the input signal(s) from the input terminals and connect instead a simulator suited for simulating the actual input setup for each active input channel. |
| 3    | Apply input value(s) to each active channel, corresponding to 0% and 100% output range.   |
| 4    | Observe whether the output acts as expected.  |
| 5    | Restore the input terminals to normal operation, i.e. re-connect the input signal(s).   |

|   |  |
|---|--|
| 6 | Measure the process value (temperature) at the connected input(s) and observe that the output current corresponds to the applied input value(s). |
| 7 | Remove the bypass from the safety PLC or otherwise restore normal operation.   |

## 14 Procedures to repair or replace the product

Any failures that are detected and that compromise functional safety should be reported to the sales department at PR electronics A/S.

Repair of the device must be done by PR electronics A/S only.

## 15 Maintenance

No maintenance required.

## 16 Configuration of the transmitter

The 5435/5437/6437 can be configured by use of a HART configurator or a HART modem used with PReset or other Software tools supporting 5435/5437/6437 (see restrictions for using PR5909 Loop Link interface in "Section 5.4.6 Analog output" on page 6).

Independent of the tools used, the configuration parameters are the same, and for safety applications all parameters described in "Section 17.1 Safety-related configuration parameters" on page 14 must be configured correctly.

Note that the dual channel version of the 6437 DIN rail transmitter contains two independent transmitters in one DIN rail enclosure. This means that the transmitter for each channel contains a full set of parameters.

Although most parameters are simple and the description is understandable, some parameters require special descriptions given in the sections below.

### 16.1 Password protection

Write protection of the configuration is possible using either HW jumper or using password protection.

During configuration of the device parameters, both write protection mechanisms must be disabled.

For valid SIL mode, the password protection must be set to active, see "Section 17.1.6 HART parameters" on page 22, and entering SIL mode is not possible if this is not done. The configuration tool must support password protection if SIL mode is required.

After SIL mode is entered, it is optional to set the HW protection jumper for extra protection.

#### 16.1.1 Changing password

The password used for write protection must consist of exactly 8 characters. Any character specified in ISO Latin-1 (ISO 8859-1) can be used and will be supported by the configuration tool.

The default configured password is "\*\*\*\*\*" (8 character #42).

To change the password, locate the menu "Write Protection" in the configuration tool. Select "Change Password" or "New Password" dependent on the tool used.

When prompted, the already configured password must be entered for access.

#### 16.1.2 Enabling password protection

For enabling write protection, locate the menu "Write Protection" in the configuration tool. Select "Enabled" or "Write protect" dependent on the tool used.

When prompted, the already configured password must be entered for access.

#### 16.1.3 Disabling password protection

For disabling write protection, locate the menu "Write Protection" in the configuration tool. Select "Disabled" or "Write enable" dependent on the tool used.

When prompted, the already configured password must be entered for access.

The configuration tool will not support disabling password protection if the device is in SIL mode.

Note: if the device is in SIL mode this will be exited if the password protection is disabled!

### 16.2 Process calibration (input trimming)

If a sensor is not accurate, or anything else in the process being monitored is affecting the measurement linearly, this can be compensated by the transmitter by entering up to two reference values for Input 1 and Input 2 independently.

A process calibration (input trimming) can be done by the end user. A known process signal must be applied for either low – or for both low and high - end of the input measurement range for each input.



**Process calibration/input trimming is optional for SIL mode. If used, the required accuracy must be verified by the end user and it must be verified by test that the applied process calibration does not introduce failures exceeding the requirements for the safety application.**

The procedures for trimming is not supported by all configuration tools.

### 16.2.1 Lower trim point (offset/taring)

If only an offset adjustment or a taring of the input shall be done, this procedure shall be followed:

- a. Remove the output current from any automatic control application.
- b. Locate the menu "Calibration" in the configuration tool and select "Input zero calibration".
- c. Acknowledge all warnings, and select whether Input 1 or Input 2 shall be trimmed.
- d. Apply the input corresponding to 0% input, e.g. 0.0% for a potentiometer input.  
The input value must be within the configured limits for the input (Input 1 or Input 2).  
Press OK to proceed.
- e. Wait for the trimming to be performed.
- f. Re-apply the output current to the control application. Repeat the above procedure for both inputs.

### 16.2.2 Lower and upper trim point

If both the lower and upper range shall be trimmed, this procedure shall be followed:

- a. Remove the output current from any automatic control application.
- b. Locate the menu "Calibration" in the configuration tool and select "Input calibration".
- c. Acknowledge all warnings, and select whether Input 1 or Input 2 shall be trimmed.
- d. Apply the input where the low point of the trimming range shall be performed, e.g. 10.03% for a potentiometer input.  
The input value must be within the configured limits for the input (Input 1 or Input 2). Press OK to proceed.
- e. The previously trimmed lower point value is shown, and the currently applied input value is monitored continuously and shown, e.g. 10.47% for a potentiometer input.  
When the currently applied value reading is stable, press OK to proceed.
- f. Enter the reference value of the applied input value, e.g. 10.03% for a potentiometer input.
- g. The currently applied trimmed input value is now monitored and shown. If the value is matching the entered reference value, press "Yes" and proceed to step h.  
If not, press "No", and step d to g will be repeated.
- h. Repeat step d to g for the upper trim point of the trimming range, e.g. 90.04% for a potentiometer input.
- i. Select whether the other input should be trimmed at this time, or if the trimming should be repeated, and the steps c to g will be repeated for the selected sensor.

Repeat the above procedure until both lower and upper point show the applied input value correctly for both inputs.

*Note: The procedure can be aborted at any step, but after step f, a partial calibration may have been applied, and a previous calibration thereby lost. See "Section 16.2.3 Restore factory calibration" on page 13.*

### 16.2.3 Restore factory calibration

Any user-performed process calibration/input trimming can be reset to factory calibration values. This can be done independently for both Input 1 and Input 2.

Be aware that any performed process calibration/input trimming will be lost for the sensor selected.

- a. Locate the menu "Calibration" in the configuration tool and select "Restore factory calibration".
- b. Acknowledge all warnings, and select whether Input 1 or Input 2 shall be restored.
- c. Any previously performed upper and lower trim points will be shown. Press "Yes" to proceed or "No" to abort the operation.
- d. The resulting upper and lower trim points will be set to 0.

## 16.3 Limit Check

### 16.3.1 Input

If the input (1 or 2) that is mapped to PV, and thereby the Analog Output, exceeds either of the input range limits configured in the *Input 1 Lower/Upper Limit* or *Input 2 Lower/Upper Limit*, this will be indicated as an error on the analog output current. This is also the case if the input is indirectly mapped to PV (e.g. Average or Difference).

**In SIL mode, Input Limit Check *must* be enabled.**

## 16.3.2 Output

If the calculated analog output value exceeds either of the *Output Lower Limit* or *Output Upper Limit* this will be indicated as an error on the analog output current (See also restrictions described in 5.4.6 Analog output).

## 16.4 Backup functionality

Applicable for variants 5437A2/5437D2 and 6437A2/6437D2 (dual input types).

If both Inputs are enabled (*Input 2 Input Type* is different from “None”), and the *PV Mapped To* parameter are configured to any of the DV 10 to DV 14, a backup function is enabled.

These DV’s will all have:

- the value of Input 1 when a sensor error is detected on Input 2
- the value of Input 2 when a sensor error is detected on Input 1

If no Sensor Error is detected, their value will be as their name indicates (Input 1, Input 2, Average, Minimum or Maximum).

The backup function will only work if Sensor Error detection is enabled, i.e. *Sensor Error Action* is different from “None”.

## 17 Safe parameterization - user responsibility

It is the responsibility of the user to configure the transmitter so that it fits the required safety application.

The safe parametrization can be done with assist from any tool that can configure and verify the parameters described, and that supports the procedures described in this section.

The configuration tool must be specifically developed to support this, i.e. a generic HART tool cannot be used, but a device specific DD or DTM running in a generic framework is acceptable.

It is the overall responsibility of the user that the tool used for safe parametrization fulfills all requirements specified in this section.

### 17.1 Safety-related configuration parameters

#### 17.1.1 Input 1 parameters

| Parameter Name     | Verification user                               | Description   |  |            |            |            |       |       |      |   |        |     |        |          |   |     |      |        |               |   |     |   |         |  |      |     |    |           |                    |      |     |    |            |                     |      |     |    |            |                     |      |     |    |            |                     |      |     |    |             |                      |      |     |    |         |  |      |     |    |           |  |      |     |    |            |   |      |     |    |            |   |      |     |    |          |  |     |     |    |           |                       |     |     |    |
|--------------------|---|---|--|------------|------------|------------|-------|-------|------|---|--------|-----|--------|----------|---|-----|------|--------|---------------|---|-----|---|---------|--|------|-----|----|-----------|--------------------|------|-----|----|------------|---------------------|------|-----|----|------------|---------------------|------|-----|----|------------|---------------------|------|-----|----|-------------|----------------------|------|-----|----|---------|--|------|-----|----|-----------|--|------|-----|----|------------|---|------|-----|----|------------|---|------|-----|----|----------|--|-----|-----|----|-----------|-----------------------|-----|-----|----|
| Input 1 Input Type | "01 InputType 1"                                | Input type for Input 1<br>The range of other parameters can be depending on this parameter.<br>NOTE: Only the Input Types listed are valid for SIL mode.  |  |            |            |            |       |       |      |   |        |     |        |          |   |     |      |        |               |   |     |   |         |  |      |     |    |           |                    |      |     |    |            |                     |      |     |    |            |                     |      |     |    |            |                     |      |     |    |             |                      |      |     |    |         |  |      |     |    |           |  |      |     |    |            |   |      |     |    |            |   |      |     |    |          |  |     |     |    |           |                       |     |     |    |
|                    |   | <table border="1"> <thead> <tr> <th></th> <th>Input Type</th> <th>Min. Range</th> <th>Max. Range</th> <th>Units</th> </tr> </thead> <tbody> <tr> <td>"Ohm"</td> <td>Ohms</td> <td>0</td> <td>100000</td> <td>Ohm</td> </tr> <tr> <td>"kOhm"</td> <td>kiloOhms</td> <td>0</td> <td>100</td> <td>kOhm</td> </tr> <tr> <td>"Potm"</td> <td>Potentiometer</td> <td>0</td> <td>100</td> <td>%</td> </tr> <tr> <td>"PtIEC"</td> <td>RTD Pt x - IEC751,<br/>10 ≤ x ≤ 10.000 NOTE 1</td> <td>-200</td> <td>850</td> <td>°C</td> </tr> <tr> <td>"Pt50IEC"</td> <td>RTD Pt 50 - IEC751</td> <td>-200</td> <td>850</td> <td>°C</td> </tr> <tr> <td>"Pt100IEC"</td> <td>RTD Pt 100 - IEC751</td> <td>-200</td> <td>850</td> <td>°C</td> </tr> <tr> <td>"Pt200IEC"</td> <td>RTD Pt 200 - IEC751</td> <td>-200</td> <td>850</td> <td>°C</td> </tr> <tr> <td>"Pt500IEC"</td> <td>RTD Pt 500 - IEC751</td> <td>-200</td> <td>850</td> <td>°C</td> </tr> <tr> <td>"Pt1000IEC"</td> <td>RTD Pt 1000 - IEC751</td> <td>-200</td> <td>850</td> <td>°C</td> </tr> <tr> <td>"PtJIS"</td> <td>RTD Pt x - JIS C1604-81,<br/>10 ≤ x ≤ 10.000 NOTE 1</td> <td>-200</td> <td>649</td> <td>°C</td> </tr> <tr> <td>"Pt50JIS"</td> <td>RTD Pt 50 – JIS C1604-81<br/>(R100/R0 = 1.3916)</td> <td>-200</td> <td>649</td> <td>°C</td> </tr> <tr> <td>"Pt100JIS"</td> <td>RTD Pt 100 - JIS C1604-81<br/>(R100/R0 = 1.3916)</td> <td>-200</td> <td>649</td> <td>°C</td> </tr> <tr> <td>"Pt200JIS"</td> <td>RTD Pt 200 - JIS C1604-81<br/>(R100/R0 = 1.3916)</td> <td>-200</td> <td>649</td> <td>°C</td> </tr> <tr> <td>"NixDIN"</td> <td>RTD Ni x - DIN43760,<br/>10 ≤ x ≤ 10.000 NOTE 1</td> <td>-60</td> <td>250</td> <td>°C</td> </tr> <tr> <td>"Ni50DIN"</td> <td>RTD Ni 50 - DIN 43760</td> <td>-60</td> <td>250</td> <td>°C</td> </tr> </tbody> </table> |  | Input Type | Min. Range | Max. Range | Units | "Ohm" | Ohms | 0 | 100000 | Ohm | "kOhm" | kiloOhms | 0 | 100 | kOhm | "Potm" | Potentiometer | 0 | 100 | % | "PtIEC" | RTD Pt x - IEC751,<br>10 ≤ x ≤ 10.000 NOTE 1 | -200 | 850 | °C | "Pt50IEC" | RTD Pt 50 - IEC751 | -200 | 850 | °C | "Pt100IEC" | RTD Pt 100 - IEC751 | -200 | 850 | °C | "Pt200IEC" | RTD Pt 200 - IEC751 | -200 | 850 | °C | "Pt500IEC" | RTD Pt 500 - IEC751 | -200 | 850 | °C | "Pt1000IEC" | RTD Pt 1000 - IEC751 | -200 | 850 | °C | "PtJIS" | RTD Pt x - JIS C1604-81,<br>10 ≤ x ≤ 10.000 NOTE 1 | -200 | 649 | °C | "Pt50JIS" | RTD Pt 50 – JIS C1604-81<br>(R100/R0 = 1.3916) | -200 | 649 | °C | "Pt100JIS" | RTD Pt 100 - JIS C1604-81<br>(R100/R0 = 1.3916) | -200 | 649 | °C | "Pt200JIS" | RTD Pt 200 - JIS C1604-81<br>(R100/R0 = 1.3916) | -200 | 649 | °C | "NixDIN" | RTD Ni x - DIN43760,<br>10 ≤ x ≤ 10.000 NOTE 1 | -60 | 250 | °C | "Ni50DIN" | RTD Ni 50 - DIN 43760 | -60 | 250 | °C |
|                    |   |   | Input Type   | Min. Range | Max. Range | Units      |       |       |      |   |        |     |        |          |   |     |      |        |               |   |     |   |         |  |      |     |    |           |                    |      |     |    |            |                     |      |     |    |            |                     |      |     |    |            |                     |      |     |    |             |                      |      |     |    |         |  |      |     |    |           |  |      |     |    |            |   |      |     |    |            |   |      |     |    |          |  |     |     |    |           |                       |     |     |    |
|                    |   | "Ohm"   | Ohms   | 0          | 100000     | Ohm        |       |       |      |   |        |     |        |          |   |     |      |        |               |   |     |   |         |  |      |     |    |           |                    |      |     |    |            |                     |      |     |    |            |                     |      |     |    |            |                     |      |     |    |             |                      |      |     |    |         |  |      |     |    |           |  |      |     |    |            |   |      |     |    |            |   |      |     |    |          |  |     |     |    |           |                       |     |     |    |
|                    |   | "kOhm"  | kiloOhms   | 0          | 100        | kOhm       |       |       |      |   |        |     |        |          |   |     |      |        |               |   |     |   |         |  |      |     |    |           |                    |      |     |    |            |                     |      |     |    |            |                     |      |     |    |            |                     |      |     |    |             |                      |      |     |    |         |  |      |     |    |           |  |      |     |    |            |   |      |     |    |            |   |      |     |    |          |  |     |     |    |           |                       |     |     |    |
|                    |   | "Potm"  | Potentiometer                                      | 0          | 100        | %          |       |       |      |   |        |     |        |          |   |     |      |        |               |   |     |   |         |  |      |     |    |           |                    |      |     |    |            |                     |      |     |    |            |                     |      |     |    |            |                     |      |     |    |             |                      |      |     |    |         |  |      |     |    |           |  |      |     |    |            |   |      |     |    |            |   |      |     |    |          |  |     |     |    |           |                       |     |     |    |
|                    |   | "PtIEC"   | RTD Pt x - IEC751,<br>10 ≤ x ≤ 10.000 NOTE 1       | -200       | 850        | °C         |       |       |      |   |        |     |        |          |   |     |      |        |               |   |     |   |         |  |      |     |    |           |                    |      |     |    |            |                     |      |     |    |            |                     |      |     |    |            |                     |      |     |    |             |                      |      |     |    |         |  |      |     |    |           |  |      |     |    |            |   |      |     |    |            |   |      |     |    |          |  |     |     |    |           |                       |     |     |    |
|                    |   | "Pt50IEC"   | RTD Pt 50 - IEC751                                 | -200       | 850        | °C         |       |       |      |   |        |     |        |          |   |     |      |        |               |   |     |   |         |  |      |     |    |           |                    |      |     |    |            |                     |      |     |    |            |                     |      |     |    |            |                     |      |     |    |             |                      |      |     |    |         |  |      |     |    |           |  |      |     |    |            |   |      |     |    |            |   |      |     |    |          |  |     |     |    |           |                       |     |     |    |
|                    |   | "Pt100IEC"  | RTD Pt 100 - IEC751                                | -200       | 850        | °C         |       |       |      |   |        |     |        |          |   |     |      |        |               |   |     |   |         |  |      |     |    |           |                    |      |     |    |            |                     |      |     |    |            |                     |      |     |    |            |                     |      |     |    |             |                      |      |     |    |         |  |      |     |    |           |  |      |     |    |            |   |      |     |    |            |   |      |     |    |          |  |     |     |    |           |                       |     |     |    |
|                    |   | "Pt200IEC"  | RTD Pt 200 - IEC751                                | -200       | 850        | °C         |       |       |      |   |        |     |        |          |   |     |      |        |               |   |     |   |         |  |      |     |    |           |                    |      |     |    |            |                     |      |     |    |            |                     |      |     |    |            |                     |      |     |    |             |                      |      |     |    |         |  |      |     |    |           |  |      |     |    |            |   |      |     |    |            |   |      |     |    |          |  |     |     |    |           |                       |     |     |    |
|                    |   | "Pt500IEC"  | RTD Pt 500 - IEC751                                | -200       | 850        | °C         |       |       |      |   |        |     |        |          |   |     |      |        |               |   |     |   |         |  |      |     |    |           |                    |      |     |    |            |                     |      |     |    |            |                     |      |     |    |            |                     |      |     |    |             |                      |      |     |    |         |  |      |     |    |           |  |      |     |    |            |   |      |     |    |            |   |      |     |    |          |  |     |     |    |           |                       |     |     |    |
|                    |   | "Pt1000IEC"   | RTD Pt 1000 - IEC751                               | -200       | 850        | °C         |       |       |      |   |        |     |        |          |   |     |      |        |               |   |     |   |         |  |      |     |    |           |                    |      |     |    |            |                     |      |     |    |            |                     |      |     |    |            |                     |      |     |    |             |                      |      |     |    |         |  |      |     |    |           |  |      |     |    |            |   |      |     |    |            |   |      |     |    |          |  |     |     |    |           |                       |     |     |    |
|                    |   | "PtJIS"   | RTD Pt x - JIS C1604-81,<br>10 ≤ x ≤ 10.000 NOTE 1 | -200       | 649        | °C         |       |       |      |   |        |     |        |          |   |     |      |        |               |   |     |   |         |  |      |     |    |           |                    |      |     |    |            |                     |      |     |    |            |                     |      |     |    |            |                     |      |     |    |             |                      |      |     |    |         |  |      |     |    |           |  |      |     |    |            |   |      |     |    |            |   |      |     |    |          |  |     |     |    |           |                       |     |     |    |
|                    |   | "Pt50JIS"   | RTD Pt 50 – JIS C1604-81<br>(R100/R0 = 1.3916)     | -200       | 649        | °C         |       |       |      |   |        |     |        |          |   |     |      |        |               |   |     |   |         |  |      |     |    |           |                    |      |     |    |            |                     |      |     |    |            |                     |      |     |    |            |                     |      |     |    |             |                      |      |     |    |         |  |      |     |    |           |  |      |     |    |            |   |      |     |    |            |   |      |     |    |          |  |     |     |    |           |                       |     |     |    |
|                    |   | "Pt100JIS"  | RTD Pt 100 - JIS C1604-81<br>(R100/R0 = 1.3916)    | -200       | 649        | °C         |       |       |      |   |        |     |        |          |   |     |      |        |               |   |     |   |         |  |      |     |    |           |                    |      |     |    |            |                     |      |     |    |            |                     |      |     |    |            |                     |      |     |    |             |                      |      |     |    |         |  |      |     |    |           |  |      |     |    |            |   |      |     |    |            |   |      |     |    |          |  |     |     |    |           |                       |     |     |    |
| "Pt200JIS"         | RTD Pt 200 - JIS C1604-81<br>(R100/R0 = 1.3916) | -200  | 649  | °C         |            |            |       |       |      |   |        |     |        |          |   |     |      |        |               |   |     |   |         |  |      |     |    |           |                    |      |     |    |            |                     |      |     |    |            |                     |      |     |    |            |                     |      |     |    |             |                      |      |     |    |         |  |      |     |    |           |  |      |     |    |            |   |      |     |    |            |   |      |     |    |          |  |     |     |    |           |                       |     |     |    |
| "NixDIN"           | RTD Ni x - DIN43760,<br>10 ≤ x ≤ 10.000 NOTE 1  | -60   | 250  | °C         |            |            |       |       |      |   |        |     |        |          |   |     |      |        |               |   |     |   |         |  |      |     |    |           |                    |      |     |    |            |                     |      |     |    |            |                     |      |     |    |            |                     |      |     |    |             |                      |      |     |    |         |  |      |     |    |           |  |      |     |    |            |   |      |     |    |            |   |      |     |    |          |  |     |     |    |           |                       |     |     |    |
| "Ni50DIN"          | RTD Ni 50 - DIN 43760                           | -60   | 250  | °C         |            |            |       |       |      |   |        |     |        |          |   |     |      |        |               |   |     |   |         |  |      |     |    |           |                    |      |     |    |            |                     |      |     |    |            |                     |      |     |    |            |                     |      |     |    |             |                      |      |     |    |         |  |      |     |    |           |  |      |     |    |            |   |      |     |    |            |   |      |     |    |          |  |     |     |    |           |                       |     |     |    |



| Parameter Name | Verification user | Description    |   |         |        |    |
|----------------|-------------------|----------------|---|---------|--------|----|
|                |                   | "Ni100DIN"     | RTD Ni 100 - DIN 43760                            | -60     | 250    | °C |
|                |                   | "Ni120DIN"     | RTD Ni 120 - DIN 43760                            | -60     | 250    | °C |
|                |                   | "Ni1000DIN"    | RTD Ni 1000 - DIN 43760                           | -60     | 250    | °C |
|                |                   | "CuxECW15"     | RTD Cu x - ECW No. 15,<br>5 ≤ x ≤ 1.000 NOTE 1    | -200    | 260    | °C |
|                |                   | "Cu10ECW15"    | RTD Cu 10 - ECW No. 15<br>(α = 0.00427)           | -200    | 260    | °C |
|                |                   | "Cu100ECW15"   | RTD Cu 100 - ECW No. 15<br>(α = 0.00427)          | -200    | 260    | °C |
|                |                   | "Cu50GOST-94"  | RTD Cu 50 - GOST 6651-1994<br>(α = 0.00426)       | -50     | 200    | °C |
|                |                   | "Cu50GOST-09"  | RTD Cu 50 - GOST 6651-2009<br>(α = 0.00428)       | -180    | 200    | °C |
|                |                   | "Cu100GOST-09" | RTD Cu 100 - GOST 6651-2009<br>(α = 0.00428)      | -180    | 200    | °C |
|                |                   | "Pt50GOST-09"  | RTD Pt 50 – GOST 6651-2009<br>(α = 0.00391)       | -200    | 850    | °C |
|                |                   | "Pt100GOST-09" | RTD Pt 100 – GOST 6651-2009<br>(α = 0.00391)      | -200    | 850    | °C |
|                |                   | "Cu100GOST-94" | RTD Cu 100 – GOST 6651-1994<br>(α = 0.00426)      | -50     | 200    | °C |
|                |                   | "CuxGOST-94"   | RTD Cu x – GOST 6651-1994<br>(α = 0.00426) NOTE 1 | -50     | 200    | °C |
|                |                   | "NixGOST-09"   | RTD Ni x – GOST 6651-2009<br>(α = 0.00617) NOTE 1 | -60     | 180    | °C |
|                |                   | "Ni50GOST-09"  | RTD Ni 50 – GOST 6651-2009<br>(α = 0.00617)       | -60     | 180    | °C |
|                |                   | "Ni100GOST-09" | RTD Ni 100 – GOST 6651-2009<br>(α = 0.00617)      | -60     | 180    | °C |
|                |                   | "uV±"          | Micro-Volts bipolar                               | -800000 | 800000 | uV |
|                |                   | "mV±"          | Milli-Volts bipolar                               | -800    | 800    | mV |
|                |                   | "V±"           | Volts bipolar                                     | -0.8    | 0.8    | V  |
|                |                   | "TCB-IEC"      | TC Type B - IEC 584                               | 0       | 1820   | °C |
|                |                   | "TCW5-ASTM"    | TC Type W5 - ASTM E 988                           | 0       | 2300   | °C |
|                |                   | "TCW3-ASTM"    | TC Type W3 - ASTM E 988                           | 0       | 2300   | °C |
|                |                   | "TCE-IEC584"   | TC Type E - IEC 584                               | -200    | 1000   | °C |
|                |                   | "TCJ-IEC584"   | TC Type J - IEC 584                               | -100    | 1200   | °C |
|                |                   | "TCK-IEC584"   | TC Type K - IEC 584                               | -180    | 1372   | °C |
|                |                   | "TCN-IEC584"   | TC Type N - IEC 584                               | -180    | 1300   | °C |
|                |                   | "TCR-IEC584"   | TC Type R - IEC 584                               | -50     | 1760   | °C |
|                |                   | "TCS-IEC584"   | TC Type S - IEC 584                               | -50     | 1760   | °C |
|                |                   | "TCT-IEC584"   | TC Type T - IEC 584                               | -200    | 400    | °C |
|                |                   | "TCL-DIN43710" | TC Type L - DIN 43710                             | -200    | 900    | °C |
|                |                   | "TCU-DIN43710" | TC Type U - DIN 43710                             | -200    | 600    | °C |
|                |                   | "TCLr-GOST"    | TC Type Lr - GOST 3044-84                         | -200    | 800    | °C |
|                |                   | "CuxGOST-09"   | RTD Cu x – GOST 6651-2009<br>(α = 0.00428) NOTE 1 | -180    | 200    | °C |

| Parameter Name  | Verification user | Description  |   |   |         |     |    |      |                      |         |         |    |      |                      |      |      |    |     |                |      |     |   |
|---|-------------------|--|---|---|---------|-----|----|------|----------------------|---------|---------|----|------|----------------------|------|------|----|-----|----------------|------|-----|---|
|   |                   | <table border="1"> <tr> <td>"PtXGOST-09"</td> <td>RTD Pt x – GOST 6691-2009<br/>(<math>\alpha = 0.00391</math>)<sup>NOTE 1</sup></td> <td>-200</td> <td>850</td> <td>°C</td> </tr> <tr> <td>"uV"</td> <td>Micro-Volts unipolar</td> <td>-100000</td> <td>1700000</td> <td>uV</td> </tr> <tr> <td>"mV"</td> <td>Milli-Volts unipolar</td> <td>-100</td> <td>1700</td> <td>mV</td> </tr> <tr> <td>"V"</td> <td>Volts unipolar</td> <td>-0.1</td> <td>1.7</td> <td>V</td> </tr> </table>  | "PtXGOST-09"  | RTD Pt x – GOST 6691-2009<br>( $\alpha = 0.00391$ ) <sup>NOTE 1</sup> | -200    | 850 | °C | "uV" | Micro-Volts unipolar | -100000 | 1700000 | uV | "mV" | Milli-Volts unipolar | -100 | 1700 | mV | "V" | Volts unipolar | -0.1 | 1.7 | V |
|   |                   | "PtXGOST-09"   | RTD Pt x – GOST 6691-2009<br>( $\alpha = 0.00391$ ) <sup>NOTE 1</sup> | -200  | 850     | °C  |    |      |                      |         |         |    |      |                      |      |      |    |     |                |      |     |   |
|   |                   | "uV"   | Micro-Volts unipolar  | -100000   | 1700000 | uV  |    |      |                      |         |         |    |      |                      |      |      |    |     |                |      |     |   |
|   |                   | "mV"   | Milli-Volts unipolar  | -100  | 1700    | mV  |    |      |                      |         |         |    |      |                      |      |      |    |     |                |      |     |   |
|   |                   | "V"  | Volts unipolar  | -0.1  | 1.7     | V   |    |      |                      |         |         |    |      |                      |      |      |    |     |                |      |     |   |
| Note 1: For these Input Types <i>Input 1 RTD Factor</i> applies |                   |  |   |   |         |     |    |      |                      |         |         |    |      |                      |      |      |    |     |                |      |     |   |
| Input 1 RTD Factor  | "02 RTDFactor 1"  | RTD Factor (R0) value in Ohms for Input 1.<br>Only used if a PtX, NiX or CuX sensor type is selected for <i>Input 1 Input Type</i> .<br>Range 10..10.000 Ohm for PtX and NiX, 5..1000 for CuX.   |   |   |         |     |    |      |                      |         |         |    |      |                      |      |      |    |     |                |      |     |   |
| Input 1 Number of Wires   | "03 NumWires 1"   | Number of wires used for cable compensation of Input 1.<br>Only used if an RTD, Linear Resistance or Potentiometer is selected for <i>Input 1 Input Type</i> .<br>The range is dependent on the selected <i>Input 1 Input Type</i> .<br><b>If an RTD type or Linear resistance is selected, the range is 2 – 4:</b><br>2 = The measurement is compensated with a fixed cable resistance value: <i>Input 1 Cable Resistance</i> .<br>3 = The measurement is compensated for cable resistance using 3-wires. (All sensor wires must be equal length and type).<br>4 = The measurement value is compensated for cable resistance using 4-wires.<br><br><b>If Potentiometer is selected, the range is 3 - 5:</b><br>3 = The measurement is compensated with a fixed cable resistance value: <i>Input 1 Cable Resistance</i> .<br>4 = The measurement is compensated for cable resistance using 4-wires. (All sensor wires must be equal length and type).<br>5 = The measurement value is compensated for cable resistance using 5-wires.<br><b>NOTE: 5-wire compensation is only possible for 5437A2/5437D2 or 6437A2/6437D2 (dual input types).</b><br><b>NOTE: If 2 or 3 wires (3 or 4 for Potentiometer input) is selected in SIL mode, the end user must ensure that the applied sensor wiring does not introduce failures exceeding the requirements for the safety application.</b> |   |   |         |     |    |      |                      |         |         |    |      |                      |      |      |    |     |                |      |     |   |
| Input 1 Cable Resistance  | "04 CableRes 1"   | Cable resistance for Input 1:<br>Total cable resistance in the 2 wires to an RTD or linear resistance sensor element.<br>Only used if an RTD, Linear Resistance or Potentiometer input type is selected for <i>Input 1 Input Type</i> and if 2 (3 for potentiometer) is selected for <i>Input 1 Number of Wires</i> .<br>Range 0...100 Ohm.  |   |   |         |     |    |      |                      |         |         |    |      |                      |      |      |    |     |                |      |     |   |
| Input 1 CJC Type  | "05 CJCType 1"    | Cold Junction Compensation type for Input 1.<br>Only used if a Thermocouple sensor type is selected for <i>Input 1 Input Type</i> .<br>"Int" = Internal: The internal temperature sensor is used for CJC.<br>"Ext" = External: An external connected temperature sensor is used for CJC, See <i>External CJC Type</i> .<br>"Fix" = Fixed: A fixed temperature, given in <i>Input 1 Fixed CJC Temperature</i> , is used for CJC.  |   |   |         |     |    |      |                      |         |         |    |      |                      |      |      |    |     |                |      |     |   |
| Input 1 Fixed CJC Temperature                                   | "06 CJCTemp 1"    | Value for fixed CJC temperature for Input 1<br>Only used if a Thermocouple sensor type is selected for <i>Input 1 Input Type</i> and if Fixed is selected for <i>Input 1 CJC Type</i> .<br>Range -50 to 135 degrees Celsius.   |   |   |         |     |    |      |                      |         |         |    |      |                      |      |      |    |     |                |      |     |   |
| Input 1 Lower Trim Point  | "07 LoTrimP1"     | The process value on Input 1 where the last lower value was trimmed. See <i>Input 1 Trim Offset/Trim gain</i> for details on trimming.<br>Note: If the Trimming is reset, the <i>Input 1 Lower Trim Point</i> value will be forced to 0.0 by the device.   |   |   |         |     |    |      |                      |         |         |    |      |                      |      |      |    |     |                |      |     |   |
| Input 1 Upper Trim Point  | "08 UpTrimP 1"    | The process value on Input 1 where the last upper value was trimmed. See <i>Input 1 Trim Point Offset/Trim Point gain</i> for details on trimming.<br>Note: If the Trimming is reset, the <i>Input 1 Upper Trim Point</i> value will be forced to 0.0 by the device.   |   |   |         |     |    |      |                      |         |         |    |      |                      |      |      |    |     |                |      |     |   |
| Input 1 Trim Offset   | "09 TrimOffs 1"   | Input 1 trimmed offset<br>If the <i>Input 1 Trim Offset</i> is different from 0.0, a user trimming has been applied to Input 1. The required accuracy must be verified by user. End user must verify by test that the applied trimming does not introduce failures exceeding the requirements for the safety application.  |   |   |         |     |    |      |                      |         |         |    |      |                      |      |      |    |     |                |      |     |   |

| Parameter Name    | Verification user | Description  |
|-------------------|-------------------|--|
| Input 1 Trim Gain | "10 TrimGain 1"   | Input 1 trimmed gain<br>If the <i>Input 1 Trim Gain</i> is different from 1.0, a user trimming has been applied to Input 1. End user must verify if the required accuracy is achieved. End user must verify by test that the applied trimming does not introduce failures exceeding the requirements for the safety application. |

## 17.1.2 Input 2 parameters

**NOTE: Only relevant for 5437A2/5437D2 and 6437A2/6437D2 (dual input types)**

| Parameter Name                | Verification user | Description   |   |
|-------------------------------|-------------------|---|---|
| Input 2 Input Type            | "11 InputType 2"  | As Input 1 Input Type for Input 2.<br>In addition, the Input Type "None" can be selected to disable Input 2 measurement.<br><b>Only certain combinations are allowed dependent on the configuration of Input 1 Input Type:</b>  |   |
|                               |                   | Selected Input 1 Input Type   | Allowed value for Input 2 Input Type                                      |
|                               |                   | <i>Ohms or kiloOhms or any RTD type</i>   | <i>None, Ohms, kOhms or any RTD type</i>                                  |
|                               |                   | <i>Potentiometer</i>  | <i>None or Potentiometer</i>  |
|                               |                   | <i>Micro-Volts unipolar, Milli-Volts unipolar or Volts unipolar</i>   | <i>None, Micro-Volts unipolar, Milli-Volts unipolar or Volts unipolar</i> |
|                               |                   | <i>Micro-Volts bipolar, Milli-Volts bipolar or Volts bipolar</i>  | <i>None, Micro-Volts bipolar, Milli-Volts bipolar or Volts bipolar</i>    |
|                               |                   | <i>Any TC type</i>  | <i>None, Any TC type, Ohms, kOhms or any RTD type</i>                     |
| Input 2 RTD Factor            | "12 RTDFactor 2"  | As Input 1 RTD Factor for Input 2.<br><b>NOTE: This is only relevant if Input 2 Input Type is different from None.</b>  |   |
| Input 2 Number Of Wires       | "13 NumWires 2"   | As Input 1 Number Of Wires for Input 2.<br><b>NOTE: This is only relevant if Input 2 Input Type is different from None.</b><br><b>NOTE: 5-wire compensation on potentiometer input is not possible for Input 2. 4-wire compensation on potentiometer input is not possible for Input 2 if 5-wire is selected for Input 1.</b> |   |
| Input 2 Cable Resistance      | "14 CableRes 2"   | As Input 1 Cable Resistance for Input 2.<br><b>NOTE: This is only relevant if Input 2 Input Type is different from None.</b>  |   |
| Input 2 CJC Type              | "15 CJCType 2"    | As Input 1 CJC Type for Input 2.<br><b>NOTE: This is only relevant if Input 2 Input Type is different from None.</b>  |   |
| Input 2 Fixed CJC Temperature | "16 CJCTemp 2"    | As Input 1 Fixed CJC Temperature for Input 2.<br><b>NOTE: This is only relevant if Input 2 Input Type is different from None.</b>   |   |
| Input 2 Lower Trim Point      | "17 LoTrimP 2"    | As Input 1 Lower Trim Point for Input 2.<br><b>NOTE: This is only relevant if Input 2 Input Type is different from None.</b>  |   |
| Input 2 Upper Trim Point      | "18 UpTrimP 2"    | As Input 1 Upper Trim Point for Input 2.<br><b>NOTE: This is only relevant if Input 2 Input Type is different from None.</b>  |   |
| Input 2 Trim Offset           | "19 TrimOffs 2"   | As Input 1 Trim Offset for Input 2.<br><b>NOTE: This is only relevant if Input 2 Input Type is different from None.</b>   |   |
| Input 2 Trim Gain             | "20 TrimGain 2"   | As Input 1 Trim Gain for Input 2.<br><b>NOTE: This is only relevant if Input 2 Input Type is different from None.</b>   |   |

## 17.1.3 External CJC parameters

| Parameter Name                | Verification user | Description   |
|-------------------------------|-------------------|---|
| External CJC Type             | "21 ExtCJC"       | <p>External CJC sensor Code</p> <p>Only used if either:</p> <ul style="list-style-type: none"> <li>a Thermocouple sensor type is selected for <i>Input 1 Input Type</i> and <i>External CJC</i> is selected for <i>Input 1 CJC type</i>.</li> <li>a Thermocouple sensor type is selected for <i>Input 2 Input Type</i> and <i>External CJC</i> is selected for <i>Input 2 CJC type</i>.</li> </ul> <p>"Pt100" = Pt100 (IEC751) is used as External CJC sensor<br/>           "Ni100" = Ni100 (DIN43760) is used as External CJC sensor</p>  |
| External CJC, Number of wires | "22 CJCNumWires"  | <p>Number of wires that is used for measuring external CJC sensor:</p> <p>Only used if <i>Input 1 Input Type</i> is a Thermocouple sensor type and <i>External</i> is selected for <i>Input 1 CJC Type</i>.</p> <p>"2" = 2-wire measurement compensated with the <i>External CJC Cable Resistance</i><br/>           "3" = 3-wire automatic cable resistance compensation<br/>           "4" = 4-wire automatic cable resistance compensation</p> <p><b>NOTE: If 2 or 3 is selected, the end user must ensure that the applied sensor wiring does not introduce failures exceeding the requirements for the safety application.</b></p> <p><b>NOTE: 4-wire is only possible for 5437A2/5437D2 and 6437A2/6437D2 (dual input types) and if <i>Input 2 Input Type</i> is not an RTD-type.</b></p> |
| Extern CJC Cable Resistance   | "23 CJCCableRes"  | <p>Cable resistance for external CJC Temperature Sensor:</p> <p>Total cable resistance in the 2 wires to the RTD element measuring the External CJC temperature.</p> <p>Only used if either:</p> <ul style="list-style-type: none"> <li><i>Input 1 Input Type</i> is a Thermocouple sensor type, <i>External</i> is selected for <i>Input 1 CJC Type</i> and <i>2-wire</i> is selected for <i>External CJC Number of wires</i>.</li> <li><i>Input 2 Input Type</i> is a Thermocouple sensor type, <i>External</i> is selected for <i>Input 2 CJC Type</i> and <i>2-wire</i> is selected for <i>External CJC Number of wires</i>.</li> </ul> <p>Range 0..100 Ohm.</p>  |

## 17.1.4 PV parameters

| Parameter Name | Verification user | Description   |       |          |         |       |          |         |       |             |  |       |             |  |       |          |                             |       |            |                              |       |             |                              |       |                |   |       |            |                            |       |          |                            |        |               |                                |        |               |                                |        |              |                                     |        |              |                                     |
|----------------|-------------------|---|-------|----------|---------|-------|----------|---------|-------|-------------|--|-------|-------------|--|-------|----------|-----------------------------|-------|------------|------------------------------|-------|-------------|------------------------------|-------|----------------|---|-------|------------|----------------------------|-------|----------|----------------------------|--------|---------------|--------------------------------|--------|---------------|--------------------------------|--------|--------------|-------------------------------------|--------|--------------|-------------------------------------|
| PV Mapped To   | "24 PVMap"        | <p>Device variable assigned to Primary Variable.</p> <p>The DV performing the appropriate measurement function (applicable to the PV and thereby the analog output).</p> <table border="0"> <tr> <td>DV 0:</td> <td>"Input1"</td> <td>Input 1</td> </tr> <tr> <td>DV 1:</td> <td>"Input2"</td> <td>Input 2</td> </tr> <tr> <td>DV 2:</td> <td>"Input1CJC"</td> <td>Input 1 CJC temperature, only valid if Input 1 is a TC</td> </tr> <tr> <td>DV 3:</td> <td>"Input2CJC"</td> <td>Input 2 CJC temperature, only valid if Input 2 is a TC</td> </tr> <tr> <td>DV 4:</td> <td>"Avg112"</td> <td>Average Input 1 and Input 2</td> </tr> <tr> <td>DV 5:</td> <td>"Diff1-12"</td> <td>Difference Input 1 - Input 2</td> </tr> <tr> <td>DV 6:</td> <td>"Diff12-11"</td> <td>Difference Input 2 - Input 1</td> </tr> <tr> <td>DV 7:</td> <td>"AbsDiff11-12"</td> <td>Absolute difference (Input 1 - Input 2)</td> </tr> <tr> <td>DV 8:</td> <td>"Min1S112"</td> <td>Minimum (Input 1, Input 2)</td> </tr> <tr> <td>DV 9:</td> <td>"Max112"</td> <td>Maximum (Input 1, Input 2)</td> </tr> <tr> <td>DV 10:</td> <td>"I1W12Backup"</td> <td>Input 1 with Input 2 as backup</td> </tr> <tr> <td>DV 11:</td> <td>"I2W11Backup"</td> <td>Input 2 with Input 1 as backup</td> </tr> <tr> <td>DV 12:</td> <td>"Avg112Back"</td> <td>Average with Input 1 or 2 as backup</td> </tr> <tr> <td>DV 13:</td> <td>"Min112Back"</td> <td>Minimum with Input 1 or 2 as backup</td> </tr> </table> | DV 0: | "Input1" | Input 1 | DV 1: | "Input2" | Input 2 | DV 2: | "Input1CJC" | Input 1 CJC temperature, only valid if Input 1 is a TC | DV 3: | "Input2CJC" | Input 2 CJC temperature, only valid if Input 2 is a TC | DV 4: | "Avg112" | Average Input 1 and Input 2 | DV 5: | "Diff1-12" | Difference Input 1 - Input 2 | DV 6: | "Diff12-11" | Difference Input 2 - Input 1 | DV 7: | "AbsDiff11-12" | Absolute difference (Input 1 - Input 2) | DV 8: | "Min1S112" | Minimum (Input 1, Input 2) | DV 9: | "Max112" | Maximum (Input 1, Input 2) | DV 10: | "I1W12Backup" | Input 1 with Input 2 as backup | DV 11: | "I2W11Backup" | Input 2 with Input 1 as backup | DV 12: | "Avg112Back" | Average with Input 1 or 2 as backup | DV 13: | "Min112Back" | Minimum with Input 1 or 2 as backup |
| DV 0:          | "Input1"          | Input 1   |       |          |         |       |          |         |       |             |  |       |             |  |       |          |                             |       |            |                              |       |             |                              |       |                |   |       |            |                            |       |          |                            |        |               |                                |        |               |                                |        |              |                                     |        |              |                                     |
| DV 1:          | "Input2"          | Input 2   |       |          |         |       |          |         |       |             |  |       |             |  |       |          |                             |       |            |                              |       |             |                              |       |                |   |       |            |                            |       |          |                            |        |               |                                |        |               |                                |        |              |                                     |        |              |                                     |
| DV 2:          | "Input1CJC"       | Input 1 CJC temperature, only valid if Input 1 is a TC  |       |          |         |       |          |         |       |             |  |       |             |  |       |          |                             |       |            |                              |       |             |                              |       |                |   |       |            |                            |       |          |                            |        |               |                                |        |               |                                |        |              |                                     |        |              |                                     |
| DV 3:          | "Input2CJC"       | Input 2 CJC temperature, only valid if Input 2 is a TC  |       |          |         |       |          |         |       |             |  |       |             |  |       |          |                             |       |            |                              |       |             |                              |       |                |   |       |            |                            |       |          |                            |        |               |                                |        |               |                                |        |              |                                     |        |              |                                     |
| DV 4:          | "Avg112"          | Average Input 1 and Input 2   |       |          |         |       |          |         |       |             |  |       |             |  |       |          |                             |       |            |                              |       |             |                              |       |                |   |       |            |                            |       |          |                            |        |               |                                |        |               |                                |        |              |                                     |        |              |                                     |
| DV 5:          | "Diff1-12"        | Difference Input 1 - Input 2  |       |          |         |       |          |         |       |             |  |       |             |  |       |          |                             |       |            |                              |       |             |                              |       |                |   |       |            |                            |       |          |                            |        |               |                                |        |               |                                |        |              |                                     |        |              |                                     |
| DV 6:          | "Diff12-11"       | Difference Input 2 - Input 1  |       |          |         |       |          |         |       |             |  |       |             |  |       |          |                             |       |            |                              |       |             |                              |       |                |   |       |            |                            |       |          |                            |        |               |                                |        |               |                                |        |              |                                     |        |              |                                     |
| DV 7:          | "AbsDiff11-12"    | Absolute difference (Input 1 - Input 2)   |       |          |         |       |          |         |       |             |  |       |             |  |       |          |                             |       |            |                              |       |             |                              |       |                |   |       |            |                            |       |          |                            |        |               |                                |        |               |                                |        |              |                                     |        |              |                                     |
| DV 8:          | "Min1S112"        | Minimum (Input 1, Input 2)  |       |          |         |       |          |         |       |             |  |       |             |  |       |          |                             |       |            |                              |       |             |                              |       |                |   |       |            |                            |       |          |                            |        |               |                                |        |               |                                |        |              |                                     |        |              |                                     |
| DV 9:          | "Max112"          | Maximum (Input 1, Input 2)  |       |          |         |       |          |         |       |             |  |       |             |  |       |          |                             |       |            |                              |       |             |                              |       |                |   |       |            |                            |       |          |                            |        |               |                                |        |               |                                |        |              |                                     |        |              |                                     |
| DV 10:         | "I1W12Backup"     | Input 1 with Input 2 as backup  |       |          |         |       |          |         |       |             |  |       |             |  |       |          |                             |       |            |                              |       |             |                              |       |                |   |       |            |                            |       |          |                            |        |               |                                |        |               |                                |        |              |                                     |        |              |                                     |
| DV 11:         | "I2W11Backup"     | Input 2 with Input 1 as backup  |       |          |         |       |          |         |       |             |  |       |             |  |       |          |                             |       |            |                              |       |             |                              |       |                |   |       |            |                            |       |          |                            |        |               |                                |        |               |                                |        |              |                                     |        |              |                                     |
| DV 12:         | "Avg112Back"      | Average with Input 1 or 2 as backup   |       |          |         |       |          |         |       |             |  |       |             |  |       |          |                             |       |            |                              |       |             |                              |       |                |   |       |            |                            |       |          |                            |        |               |                                |        |               |                                |        |              |                                     |        |              |                                     |
| DV 13:         | "Min112Back"      | Minimum with Input 1 or 2 as backup   |       |          |         |       |          |         |       |             |  |       |             |  |       |          |                             |       |            |                              |       |             |                              |       |                |   |       |            |                            |       |          |                            |        |               |                                |        |               |                                |        |              |                                     |        |              |                                     |

| Parameter Name | Verification user | Description   |
|----------------|-------------------|---|
|                |                   | DV 14: "MaxI1I2Back" Maximum with Input 1 or 2 as backup<br>DV 15: "ElectrTemp" Electronics Temperature   |
| PV Lower Range | "25 PVLowerRng"   | PV lower range value (LRV)<br>Lower input value for the linear measurement range, i.e. the input signal value corresponding the <i>Output Range 0%</i> (4.0 mA).<br>The range is dependent on the selected Input Type for the DV selected as the <i>PV Mapped To</i> .<br>The value is shown in the units that supports the Input Type for the DV selected as the <i>PV Mapped To</i> ( e.g. "mV" for <i>mVolts bipolar</i> , "µV" for <i>micro-volts bipolar</i> , etc.).  |
| PV Upper Range | "26 PVUpperRng"   | PV upper range value (URV)<br>Upper input value for the linear measurement range, i.e. the input signal value corresponding the <i>Output Range 100%</i> (20.0 mA).<br>The range is dependent on the selected Input Type for the DV selected as the <i>PV Mapped To</i> .<br>The value is shown in the units that supports the Input Type for the DV selected as the <i>PV Mapped To</i> ( e.g. "mV" for <i>mVolts bipolar</i> , "µV" for <i>micro-volts bipolar</i> , etc.)  |
| PV Damping     | "27 PVDamp"       | Damping for the DV selected as the <i>PV Mapped To</i> .<br>Damping is a first order digital filter applied to the DV value.<br>The Damping value specifies the time constant, i.e. the time at which 63.2% of a full signal change on the input is reached on the output.<br>Valid range is 0 to 60 seconds.<br><b>NOTE: Damping value <math>\approx 0.434 * \text{Response Time}</math></b><br><b>(The response time, i.e. the time at which 90% of full signal change is reached, is approx. 2.3 times higher than the Damping).</b> |

## 17.1.5 Analog Output parameters

| Parameter Name            | Verification user                                      | Description  |
|---------------------------|--|--|
| Output Range 0%           | "28 Out0%"<br><b>NOTE 2</b>                            | Analog output at <i>PV Lower Range</i> .<br>Current in mA.<br><b>NOTE: For SIL mode the value must be exactly 4.0 mA (Conforms to NAMUR NE43).</b>   |
| Output Range 100%         | "29 Out100%"<br><b>NOTE 2</b>                          | Analog output at <i>PV Upper Range</i> .<br>Current in mA.<br><b>NOTE: For SIL mode the value must be exactly 20.0 mA (Conforms to NAMUR NE43).</b>  |
| Limit Check Configuration | "30 LimitCheck"<br>See restrictions described in 5.4.6 | Limit Check Configuration:<br>"None" = Limit Check disabled <sup>NOTE 2</sup><br>"Input" = Limit Check enabled on Input Range<br>"Output" = Limit Check enabled on Output Range <sup>NOTE 2</sup><br>"Input+Output" = Limit Check enabled on Input Range and Output Range<br><b>NOTE: For SIL mode the value must be Limit Check enabled on Input Range or Limit Check enabled on Input and Output Range.</b>    |
| Output Limit Error Value  | "31 OutLimErrVal"<br><b>NOTE 2</b>                     | Current output in mA indicating Output Limit Check error if the calculated output value is outside the limits configured in <i>Output Lower/Upper Limit</i> .<br>I.e. when Device Status bit "Loop Current Saturated" is set (only if enabled).<br>Range 3.5...23.0 mA<br><b>NOTE: For SIL mode the value must be <math>\leq 3.6</math> mA or <math>\geq 21.0</math> mA (conforms to NAMUR NE43) if Enabled.</b> |
| Output Lower Limit        | "32 OutLowLim"<br><b>NOTE 2</b>                        | Current output lower limit.<br>The current level where the output current will saturate in lower direction.<br>Current in mA.<br><b>NOTE: For SIL mode the value must be exactly 3.8 mA (Conforms to NAMUR NE43).</b>  |
| Output Upper Limit        | "33 OutUpLim"<br><b>NOTE 2</b>                         | Current output upper limit.<br>The current level where the output current will saturate in upper direction.  |

| Parameter Name             | Verification user                  | Description  |
|----------------------------|------------------------------------|--|
|                            |                                    | Current in mA.<br><b>NOTE: For SIL mode the value must be exactly 20.5 mA (Conforms to NAMUR NE43).</b>  |
| Sensor Error Action        | "34 SensorError"<br><b>NOTE 2</b>  | Sensor error action:<br>"None" = Sensor error detection disabled<br>"Broken" = Sensor error detection of broken sensor enabled<br>"Shorted" = Sensor error detection of shorted sensor enabled<br>"Broken+Short" = Sensor error detection of both broken and shorted sensor enabled<br><b>NOTE: For SIL mode the value must be Sensor error detection of Broken and Shorted enabled.</b>   |
| Broken Sensor Error Value  | "35 BrkSensVal"<br><b>NOTE 2</b>   | Broken sensor alarm analog output signal<br>Current in mA indicating broken sensor alarm.<br>Range: 3.5...23.0 mA<br><b>NOTE: For SIL mode the value must be <math>\leq 3.6\text{mA}</math> or <math>\geq 21.0\text{ mA}</math> (Conforms to NAMUR NE43).</b>  |
| Shorted Sensor Error Value | "36 ShortSensVal"<br><b>NOTE 2</b> | Shorted sensor alarm analog output signal<br>Current in mA indicating shorted sensor alarm.<br>Range: 3.5...23.0 mA<br><b>NOTE: For SIL mode the value must be <math>\leq 3.6\text{ mA}</math> or <math>\geq 21.0\text{ mA}</math> (Conforms to NAMUR NE43).</b>   |
| Sensor Drift Action        | "37 SensDrift"                     | Sensor drift action:<br>"Disable" = No detection of sensor drift<br>"Warning" = Only a warning on HART is issued if drift is detected<br>"Error" = Analog output is set to Sensor Drift Current if drift is detected<br><br><b>Note: Only valid for dual input applications i.e. <i>Input 2 Input Type</i> <math>\neq</math> "None".</b><br><br>The process values measured by Input 1 and Input 2 are compared regularly and if the absolute value of the difference $ \text{Input 1} - \text{Input 2} $ exceeds <i>Sensor Drift Limit</i> for longer than <i>Sensor Drift Timeout</i> , a sensor drift is detected.<br>If the difference is lower than the limit, the detection is cleared and the timer is reset. |
| Sensor Drift Limit         | "38 SensDriftLim"                  | Sensor drift limit:<br>Measurement limit for drift detection on difference between Input 1 and Input 2. See <i>Sensor Drift Action</i> .<br><b>NOTE: Only valid if <i>Sensor Drift</i> is not set to Disable.</b><br><b>NOTE: No units are used, since the <i>Input 1 Input Type</i> and <i>Input 2 Input Type</i> are expected to have the same measuring unit.</b>   |
| Sensor Drift Timeout       | "39 SensDriftTim"                  | Sensor drift timeout:<br>Timeout value for sensor drift detection in seconds. See <i>Sensor drift Configuration</i> .<br>Range: 0...86400 seconds (~24 hours)<br><b>NOTE: Only valid if <i>Sensor Drift</i> is not set to Disable.</b>   |
| Sensor Drift Error Value   | "40 SDriftErrVal"<br><b>NOTE 2</b> | Sensor drift alarm analog output signal:<br>Current in mA indicating sensor drift alarm.<br>Range: 3.5...23.0 mA<br><b>NOTE: Only valid if <i>Sensor Drift</i> is set to Error.</b><br><b>NOTE: For SIL mode the value must be <math>\leq 3.6\text{ mA}</math> or <math>\geq 21.0\text{ mA}</math> (conforms to NAMUR NE43).</b>   |
| Input Limits Error Value   | "41 InLimErrVal"<br><b>NOTE 2</b>  | Current output in mA indicating Input Limit Check error if Input 1 or Input 2 is outside the limits configured in <i>Input 1 Lower/Upper Limit</i> and <i>Input 2 Lower/Upper Limit</i> .<br>I.e. when the Device Status bit "Primary Value Out Of Limits" is also set.<br>Range 3.5 -23.0 mA<br><b>NOTE: For SIL mode the value must be <math>\leq 3.6\text{ mA}</math> or <math>\geq 21.0\text{ mA}</math> (conforms to NAMUR NE43).</b>   |
| Input 1 Lower Limit        | "42 LowLim 1"                      | Lower Measurement Limit for Input 1.<br>Depending on the wanted measurement (PV assignment), this value should be set to support the configured PV Range.<br>The range is dependent on the selected input type as shown for <i>Input 1 Input Type</i> .  |

| Parameter Name                   | Verification user                  | Description   |
|----------------------------------|------------------------------------|---|
|                                  |                                    | The value is shown in the units that supports the selected <i>Input 1 Input Type</i> (e.g. “mV” for <i>mVolts bipolar</i> , “ $\mu$ V” for <i>micro-volts bipolar</i> , etc.).  |
| Input 1 Upper Limit              | “43 UpLim 1”                       | Upper Measurement Limit for Input 1.<br>Depending on the wanted measurement (PV assignment), this value should be set to support the configured PV Upper Range.<br>The range is dependent on the selected input type as shown for <i>Input 1 Input Type</i> .<br>The value is shown in the units that supports the selected <i>Input 1 Input Type</i> (e.g. “mV” for <i>mVolts bipolar</i> , “ $\mu$ V” for <i>micro-volts bipolar</i> , etc.).<br>If <i>Input 1 Input Type</i> is set to <i>Potentiometer</i> , this value determines the selected potentiometer size. |
| Input 2 Lower Limit              | “44 LowLim 2”                      | As Input 1 Lower Limit for Input 2.<br><b>NOTE: This is only relevant if Input 2 Input Type is different from None.</b>   |
| Input 2 Upper Limit              | “45 UpLim 2”                       | As Input 1 Upper Limit for Input 2.<br><b>NOTE: This is only relevant if Input 2 Input Type is different from None.</b>   |
| Analog Output Calibration Gain   | “46 OutCalGain”<br><b>NOTE 2</b>   | Analog output calibration gain.<br>Loop current can be trimmed using measured loop current values with HART commands 45 and 46.<br>This parameter holds the calculated gain.<br><b>NOTE: This value must be 1.0 for SIL mode</b>  |
| Analog Output Calibration Offset | “47 OutCalOffset”<br><b>NOTE 2</b> | As above, this parameter holds the calculated offset.<br><b>NOTE: This value must be 0.0 for SIL mode</b>   |

**NOTE 2: These parameters are checked by the transmitter and will only be shown if they are not configured correctly for a SIL application.**

## 17.1.6 HART parameters

| Parameter Name    | Verification user   | Description   |
|-------------------|---|---|
| Polling Address   | “48 PollAddr”<br><b>NOTE 2</b>  | Polling address for HART communication:<br>Range HART 5 mode: 0...15, any value > 0 will result in constant 4 mA output.<br>Range HART 7 mode: 0...63<br><b>NOTE: For HART 5 this MUST be set to 0 in SIL mode.</b>   |
| Loop Current Mode | “49 LoopCurrent”<br><b>NOTE 2</b>                                       | Loop Current Mode:<br>Disable = Constant 4 mA output<br>Enable = Analog Output is proportional to measured Primary Value<br><b>NOTE: For HART 7 mode this must be set to Enable in SIL mode.</b>  |
| Write Protection  | “50 WriteProtect”<br><b>NOTE 2</b>                                      | Indicates if Write Protection is enabled<br>“HW” = The configuration is protected by HW jumper<br>“PW” = The configuration is protected by Password<br>“No” = The configuration is not protected<br><b>NOTE: The configuration must be write protected with password in SIL mode.</b>   |
| SIL Mode          | “51 SILMode”  | Indicates if SIL mode is active<br>“No” = Normal operation mode (no SIL restrictions applies)<br>“Yes” = SIL operation mode. All restrictions described in the Safety Manual applies<br>Must be “Yes” for a SIL configuration to be valid.  |
| SIL Status        | “52 SILStatus”<br>The value is not shown until the SIL mode is entered! | Indicates the result of configuration check by SIL rated SW:<br>“FAIL”: No valid configuration has been received<br>“OPEN”: Actual configuration is NOT locked (non-SIL)<br>“LOCK”: Actual configuration is locked (SIL validated)<br>“INIT”: Initial status when load/check is in progress<br><b>NOTE: Only the value “LOCK” indicates a successful SIL parametrization.</b> |



**NOTE 2: These parameters are checked by the transmitter and will only be shown if they are not configured correctly for a SIL application.**

### 17.1.7 Option Parameters

| Parameter Name         | Verification user | Description  |
|------------------------|-------------------|--|
| Mains Frequency Filter | "53 MainsFilter"  | Frequency for mains supply damping filter:<br>"50 Hz" = 50 Hz mains supply noise will be suppressed.<br>"60 Hz" = 60 Hz mains supply noise will be suppressed. |

## 17.2 Entering SIL mode

When all relevant parameters has been configured correctly according to the required safety application, the user shall request the SIL mode.

SIL mode is requested by pressing the "Change SIL mode" and "Enter SIL mode" from the configuration tool and entering the requested password (default "\*\*\*\*\*"). Optionally the password can be changed.

### 17.3 Validating all safety related Parameters

The user's validation of correct parametrization is mandatory and will be requested automatically by the configuration tool after SIL mode is requested. The tool will reset the device to make sure that the verified configuration parameters are stored non-volatile in the transmitter.

The tool will then request the transmitter to validate the currently stored safety relevant configuration parameters. If the stored configuration parameters are valid for SIL mode, a report showing every relevant parameter listed in "Section 17.1 Safety-related configuration parameters" on page 14 is requested by the configuration tool and then shown in the "human readable format" (as generated by the transmitter) to the user. The parameters may be shown one or more at a time, or as a whole, dependent on the tool.

**The reported parameters must be carefully verified by the user to be in accordance with the safety application!**

If the stored configuration parameters are not valid for SIL mode, an error report showing the invalid parameter is generated by the transmitter, and shown to the user by the configuration tool, instead of the normal report.

**If any of the parameters listed in 17.1 are not shown correctly or have an incorrect value, the procedure must be aborted by pressing "Parameters NOT OK" and the device may not be considered as being in correct SIL mode!**

If all parameters are correct, the user validates them by pressing "Parameters OK".

The tool will confirm the configuration by sending a CRC calculated over the whole parameter report, and then ask for the resulting SIL mode.

Finally, this will be polled by the tool and shown to the user.

**Only the value "LOCK" shall be accepted by the user. If the result is not shown or if anything else is shown ("OPEN", "FAIL" or "INIT"), the device shall not be considered as being in correct SIL mode!**

It may take some seconds before the correct value is shown.

Press "Status OK" to confirm the status "LOCK" and end the procedure, or press "Status Wrong" to reject if the value "LOCK" is not shown.

## 17.4 Exiting SIL mode

To exit SIL mode, press "Change SIL mode" and "Exit SIL mode" in the configuration tool, and enter the correct password when prompted.

The configuration tool will then request normal operation mode and show the resulting SIL mode to the user.

The value "OPEN" will indicate that the device is not in SIL mode, and it will then be possible to change the parameters.

### **17.5 Functional test**

After entering SIL mode, the user is responsible for making a functional test after verification of the safety parameters. The procedure described in "Section 13 Periodic proof test procedure" shall be used.

In addition, if a process calibration is taken into SIL-mode operation (refer to "Section 16.2 Process calibration (input trimming)" on page 10). It is mandatory that the accuracy of the device (and sensor, if applicable) are tested.

## **18 Fault reaction and restart condition**

When the 5435/5437/6437 detects a fault, the output will go to Safe State.

A suitable configuration tool will furthermore be able to show a diagnostic message describing the detected error.

### **18.1 Application specific faults**

If the fault is caused by a sensor error or sensor wiring, the LED on the 5435/5437/6437 will flash red and the correct output current will automatically be reestablished when the fault has been corrected.

### **18.2 Device faults**

If the fault is in the device itself (detected by internal diagnostic measures), the LED on the 5435/5437/6437 will light constantly RED.

There are 2 ways of bringing the device out of Safe State:

1. Power-cycle the device.
2. Reset the device by using a configuration tool that supports a reset of the device. If the error is persistent, the device will enter the Safe State again.

## **19 Installation**

The device must be installed as required for the SIL application according to "Section 19.1 Connections diagram" on page 25. All assumption and restrictions as described in "Section 5 Assumptions and restrictions for use of the product" must be observed.

**19.1 Connections diagram 5435/5437**

**Single input**

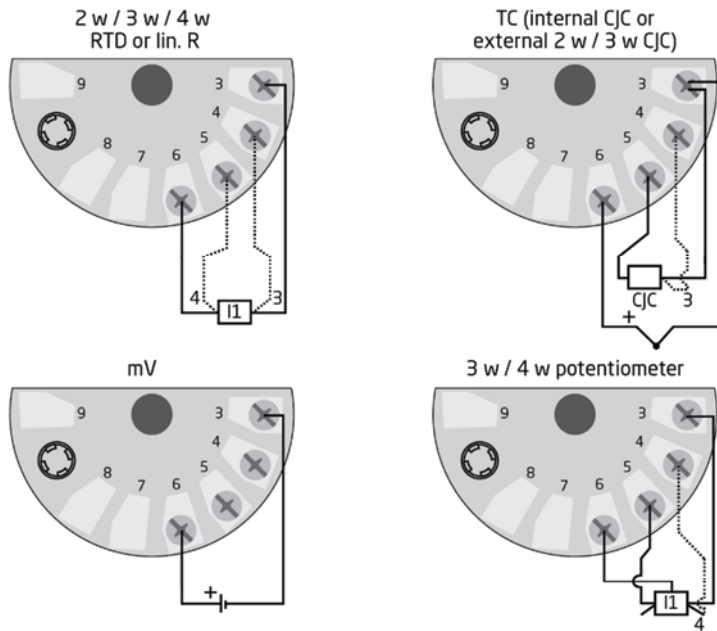

**Output**

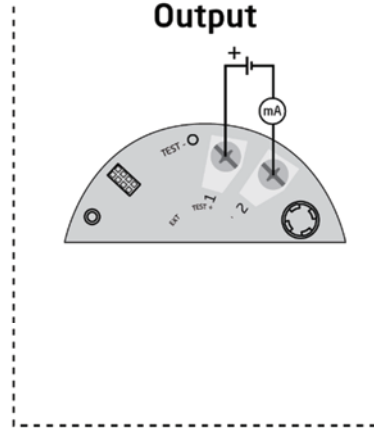

**Dual inputs**

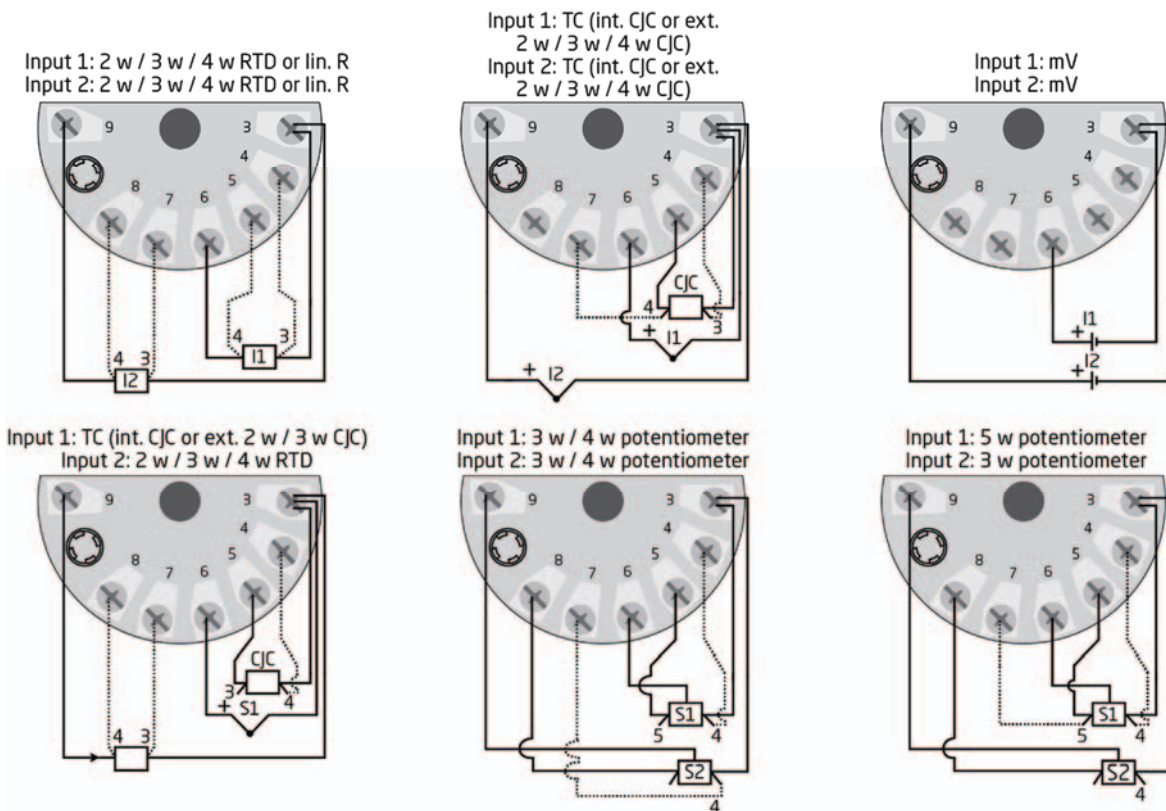

**19.2 Connections diagram 6437 single channel**

**Single input:**

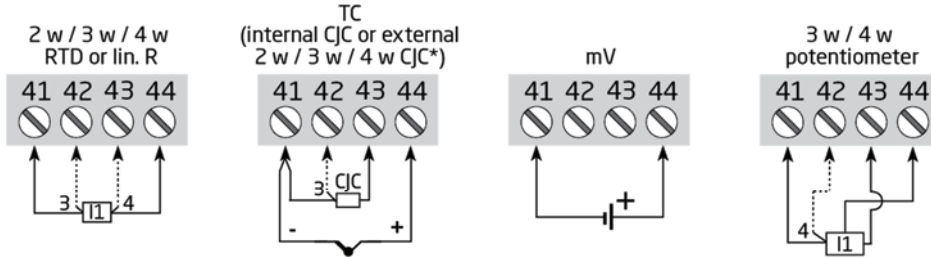

**Dual inputs:**

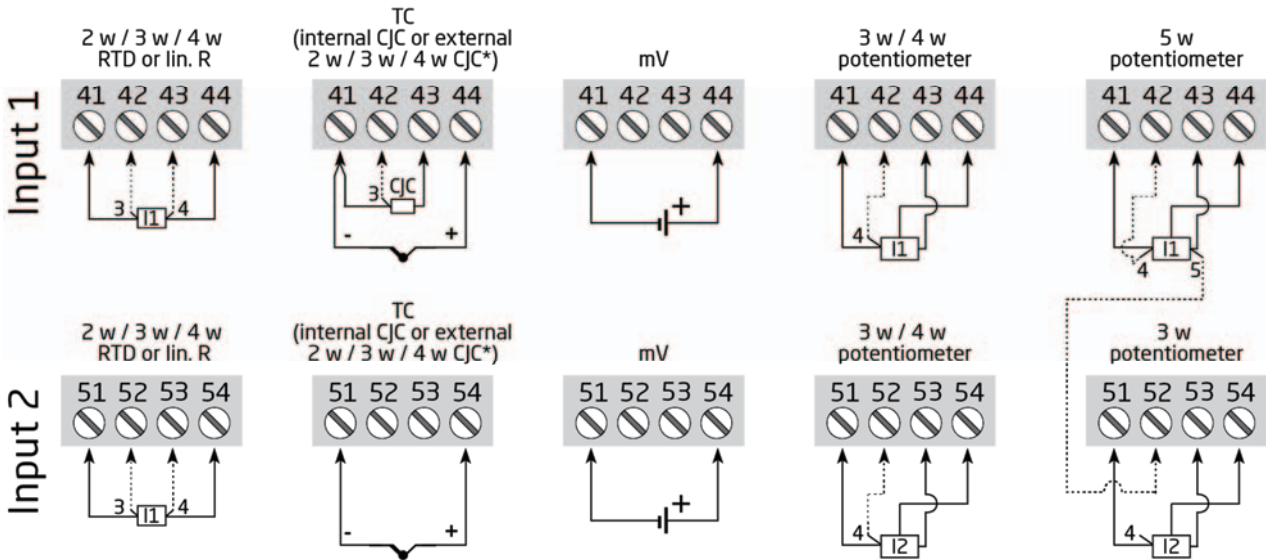

\* When using thermocouple input, the 6437 can be configured for either constant, internal or external via a Pt100 or Ni100 sensor. This must be selected during device configuration.

**Output:**

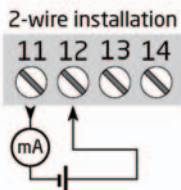

**19.3 Connections diagram 6437 dual channel**

2 x single input:

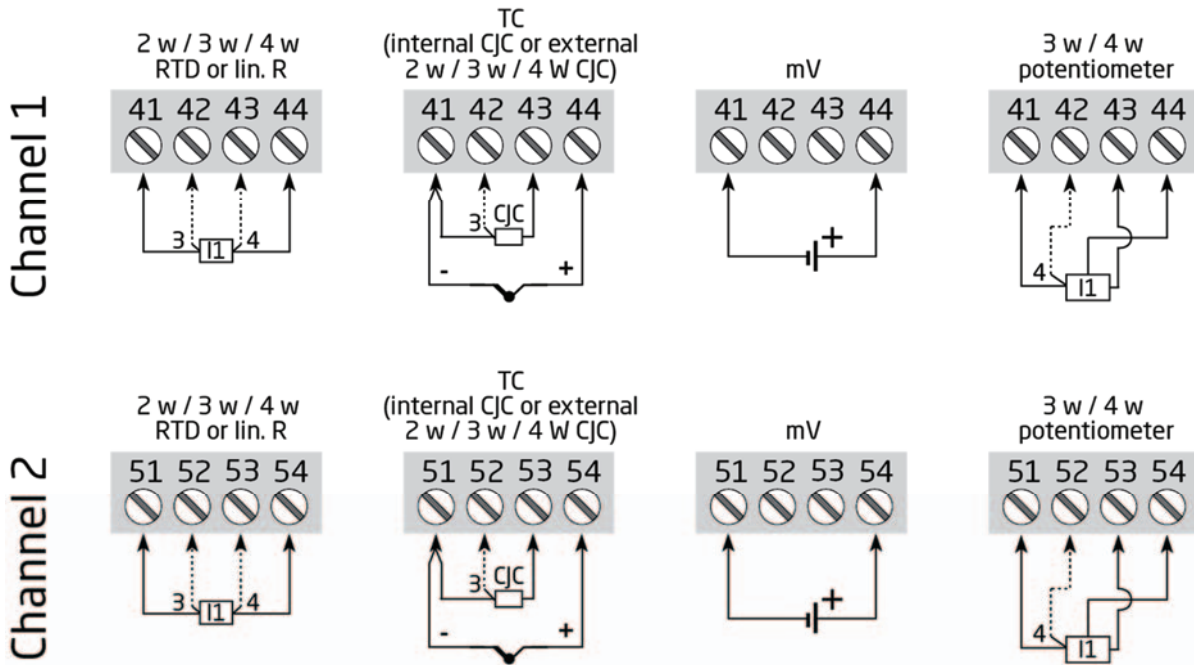

Output:

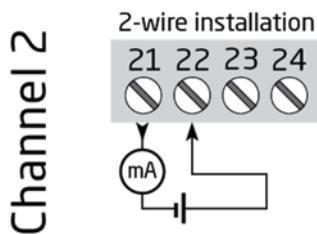
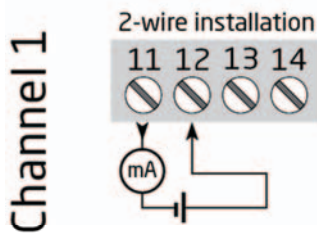

# We are near you, *all over the world*

**Our trusted red boxes are supported wherever you are**

All our devices are backed by expert service and a 5-year warranty. With each product you purchase, you receive personal technical support and guidance, day-to-day delivery, repair without charge within the warranty period and easily accessible documentation.

We are headquartered in Denmark, and have offices and authorized partners the world over. We are a local

business with a global reach. This means that we are always nearby and know your local markets well. We are committed to your satisfaction and provide **PERFORMANCE MADE SMARTER** all around the world.

For more information on our warranty program, or to meet with a sales representative in your region, visit [prelectronics.com](http://prelectronics.com).

# Benefit today from *PERFORMANCE MADE SMARTER*

PR electronics is the leading technology company specialized in making industrial process control safer, more reliable and more efficient. Since 1974, we have been dedicated to perfecting our core competence of innovating high precision technology with low power consumption. This dedication continues to set new standards for products communicating, monitoring and connecting our customers' process measurement points to their process control systems.

Our innovative, patented technologies are derived from our extensive R&D facilities and from having a great understanding of our customers' needs and processes. We are guided by principles of simplicity, focus, courage and excellence, enabling some of the world's greatest companies to achieve PERFORMANCE MADE SMARTER.