

## STT 3000 Smart Temperature Transmitter Series STT170

STT171, STT173, STT17H, STT17F, STT17C

34-TT-03-07  
August 2014

### Specification and Model Selection Guide

#### OVERVIEW

The Honeywell STT170 series of programmable temperature transmitters provides cost effective solutions for temperature monitoring applications. Compared to direct-wired temperature sensor monitoring points, the STT170 series of transmitters delivers increased accuracy, safety and reliability while also reducing wiring costs. These transmitters automatically linearize the temperature output signal bounded by the upper range value and lower range value established by the user. In addition, the user can program high or low limit alarms to activate in the case of sensor failure.

---

#### STT171 FEATURES

---

- Analog 4-20 mA output
- RTD or Ohm input
- DIN form B headmount
- NAMUR NE43 sensor error response
- Configurable using STT17C configuration tool and PC



---

#### STT173 FEATURES

---

- Analog 4-20 mA output
- RTD, T/C, Ohm or mV input
- DIN form B headmount
- NAMUR NE43 sensor error response
- Configurable using STT17C configuration tool and PC
- Galvanic isolation



---

#### STT17H FEATURES

---

- HART™/4-20 mA output
- RTD, T/C, Ohm or mV input
- Single or dual (difference or average) sensor input
- DIN form B headmount
- HART Multidrop capable
- NAMUR NE43 sensor error response
- Configurable using STT17C configuration tool and PC or HART field communicator
- Galvanic isolation



---

#### STT17F FEATURES

---

- FOUNDATION™ fieldbus protocol
- RTD, T/C, Ohm or mV input
- Single or dual (difference, average or redundant) sensor input
- DIN form B headmount
- Function blocks: 2 analogue, 1 PID
- FISCO certified
- Basic or LAS capability
- Galvanic isolation



HART is a registered trademark of the HART Communication Foundation.  
FOUNDATION is a registered trademark of the Fieldbus Foundation.

---

## Dimensions (all models)

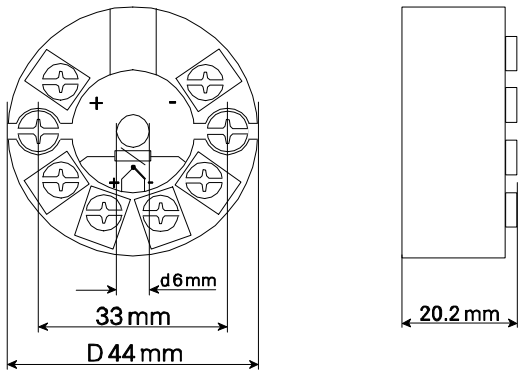

## Wiring

### STT171

#### Input:

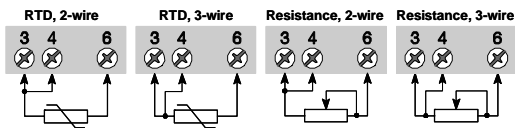

#### Output:

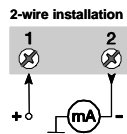

### STT173

#### Input:

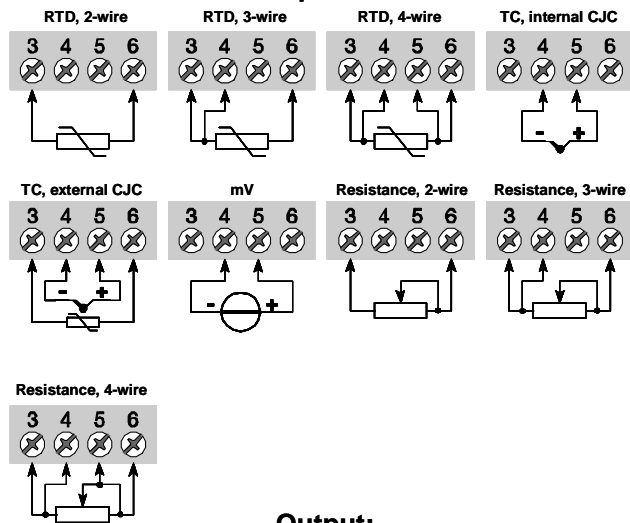

#### Output:

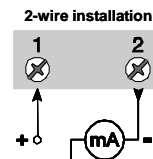

STT17H

Input:

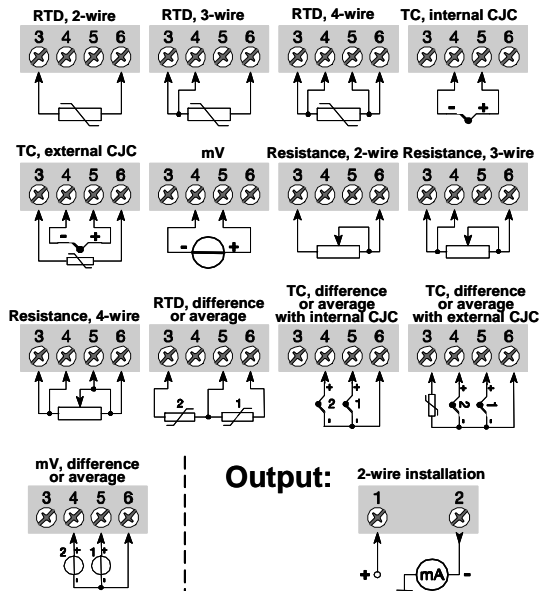

Output:

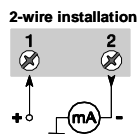

STT17F

Input:

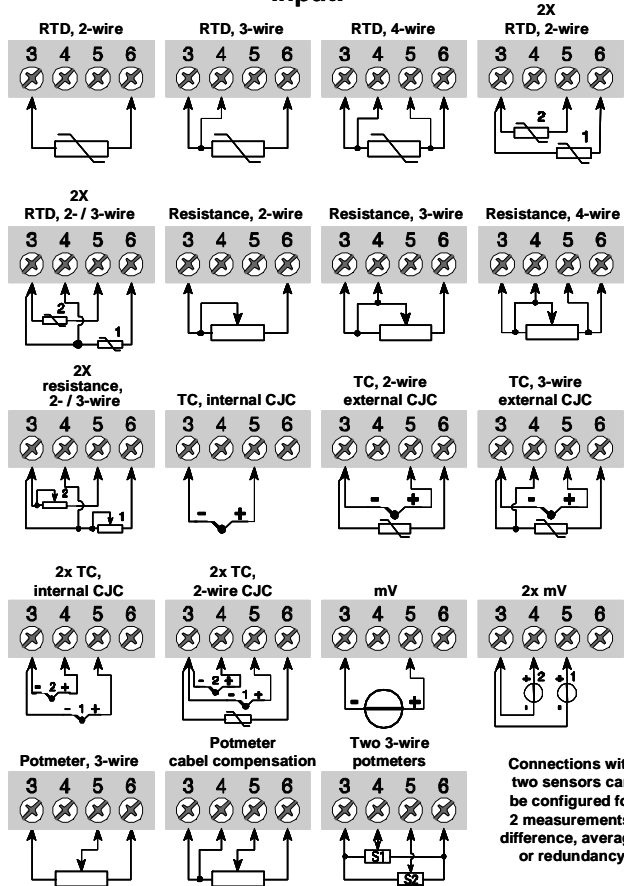

Connections with two sensors can be configured for 2 measurements, difference, average, or redundancy

Output:

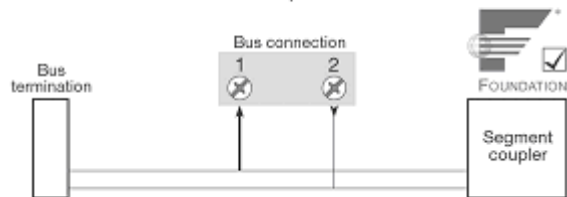

# STT17C Configuration tool

The STT17C configures the STT171, STT173 and STT17H. The intuitive graphical user interface of the STT17C virtually eliminates the need for operator training after installation on a PC. The STT17C includes all software and transmitter interface hardware necessary to configure the STT171, STT173 and STT17H in non-hazardous work environments.

**WARNING:** The STT17C is not approved for use in Hazardous work environments.

### System Requirements:

Windows® 98SE, ME, 2000 and XP with the following recommendations:

- Memory: 16 MB
- Display resolution: 800 x 600
- Hard disk space: 12 MB

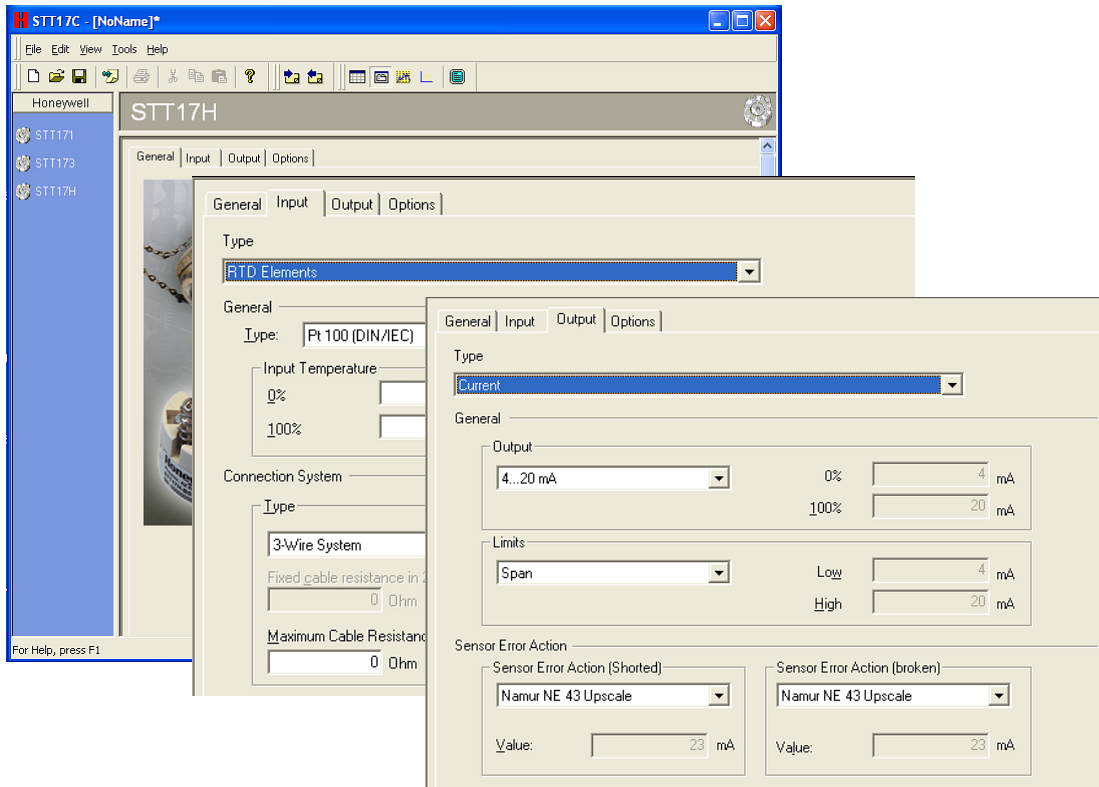
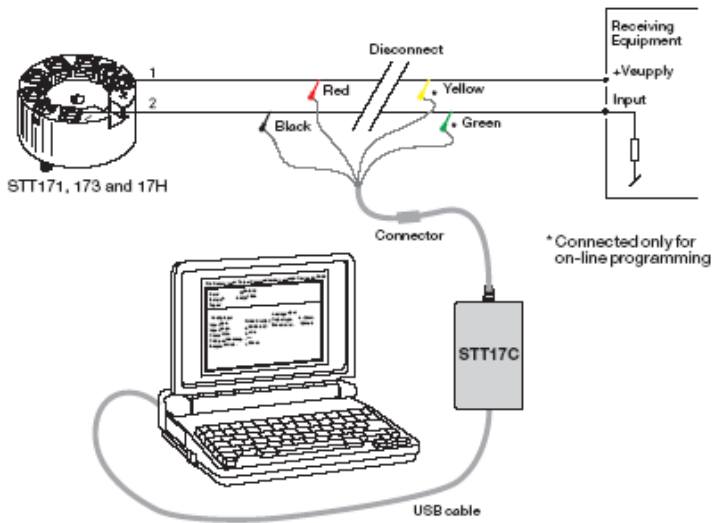

Windows is a registered trademark of Microsoft Corporation

# STT171-BS Specifications

Sensor Type	Basic Accuracy*		Rated Range		Standards	Minimum Span**	Temperature Effects per 1.0°C (1.8°F) Change in Ambient Temperature***	
	Fixed	% of Span	°C	°F			Fixed	% of Span
Pt100	0.3°C (0.54°F)	± 0.1	-200 to 850	-328 to 1562	IEC60751	25°C (45°F)	0.01°C (0.018°F)	±0.01
Ni100	0.3°C (0.54°F)	± 0.1	-60 to 250	-76 to 482	DIN 43760	25°C (45°F)	0.01°C (0.018°F)	±0.01
Ω	0.2 Ω	± 0.1	0 to 10000 Ω			30 Ω	20 mΩ	±0.01

\*whichever is greater; Total Reference Accuracy = Basic Accuracy

\*\*or 50% of upper range value, whichever is greater

\*\*\* reference temperature 24°C

## OPERATING CONDITIONS

Ambient temperature, rated..... -40 to 85°C (-40 to 185°F)  
 Humidity..... 0 to 95% RH (non-cond.)  
 Vibration..... Max 4g over 25 to 100Hz

## ELECTRICAL INPUT SPECIFICATIONS

Supply voltage..... 8 to 30 VDC  
 Power supply voltage effect..... ≤ 0.005% of span per VDC  
 Warm-up time..... 5 min  
 Response time (programmable)..... 0.33 to 60 sec

## CURRENT OUTPUT SPECIFICATIONS

Signal output range..... 4 to 20 mA  
 Update time..... 135 msec  
 Load resistance..... ≤(V supply - 8) / 0.023 A  
 0 to 870 Ω

## ALARM LEVELS

Programmable..... 3.5 to 4 mA downscale  
 20 to 23 mA upscale  
 NAMUR NE43 Upscale..... 23 mA  
 NAMUR NE43 Downscale..... 3.5 mA

## APPROVALS

### Observed Authority requirements:

EMC 2004/108/EC  
 Emmission and immunity ..... EN 61326  
 ATEX 94/9/EC..... EN 50014, EN 50020,  
 EN 50281-1-1 and EN 50284  
 FM, ASCN..... 3600, 3611, 3610  
 CSA, CAN / CSA..... C22.2 No. 157, E60079-11,  
 UL 913

### Ex / I.S. approval:

KEMA 06 ATEX 0042 X.....  II 1 GD, T80°C...T105°C  
 EEx ia IIC T4...T6

Max. amb. Temperature for T4..... 85°C  
 Max. amb. Temperature for T6..... 60°C  
 Applicable in zone..... 0, 1, 2, 20, 21 or 22  
 FM, applicable in..... IS, CL I, DIV 1, Grp. A-D, T4...T6  
 AEx ia IIC  
 NI, CL I, DIV 2, Grp. A-D, T4...T6  
 Entity, FM Installation Drawing No..... 50016324  
 CSA, applicable in..... IS, CL I, DIV 1, Grp. A-D, T4...T6  
 Ex ia IIC, AEx ia IIC  
 Entity, Installation Drawing No..... 50016326

### Ex / I.S. data:

U<sub>i</sub> (max)..... 30 VDC  
 I<sub>i</sub> (max)..... 120 mADC  
 P<sub>i</sub> (max)..... 0.84 W  
 L<sub>i</sub> (max)..... 10 μH  
 C<sub>i</sub> (max)..... 1.0 nF  
  
 U<sub>o</sub> (max)..... 27 VDC  
 I<sub>o</sub> (max)..... 7 mADC  
 P<sub>o</sub> (max)..... 45 m W  
 L<sub>o</sub> (max)..... 35 mH  
 C<sub>o</sub> (max)..... 90 nF

## STT173-BS Specifications

Sensor Type	Basic Accuracy*		Rated Range		Standards	Minimum Span**	Temperature Effects per 1.0°C (1.8°F) Change in Ambient Temperature***	
	Fixed	% of Span	°C	°F			Fixed	% of Span
Pt100	0.2°C (0.36°F)	± 0.1	-200 to +850	-328 to +1562	IEC60751	25°C (45°F)	0.01°C (0.018°F)	±0.01
Ni100	0.2°C (0.36°F)	± 0.1	-60 to +250	-76 to +482	DIN 43760	25°C (45°F)	0.01°C (0.018°F)	±0.01
B	2°C (3.6°F)	± 0.1	+400 to +1820	+752 to +3308	IEC584	200°C (360°F)	0.2°C (0.36°F)	±0.01
E	1°C (1.8°F)	± 0.1	-100 to +1000	-148 to +1832	IEC584	50°C (90°F)	0.05°C (0.09°F)	±0.01
J	1°C (1.8°F)	± 0.1	-100 to +1200	-148 to +2192	IEC584	50°C (90°F)	0.05°C (0.09°F)	±0.01
K	1°C (1.8°F)	± 0.1	-180 to +1372	-192 to +2502	IEC584	50°C (90°F)	0.05°C (0.09°F)	±0.01
L	1°C (1.8°F)	± 0.1	-100 to +900	-148 to +1652	DIN 43710	50°C (90°F)	0.05°C (0.09°F)	±0.01
N	1°C (1.8°F)	± 0.1	-180 to +1300	-292 to +2372	IEC584	100°C (180°F)	0.05°C (0.09°F)	±0.01
R	2°C (3.6°F)	± 0.1	-50 to +1760	-58 to +3200	IEC584	200°C (360°F)	0.2°C (0.36°F)	±0.01
S	2°C (3.6°F)	± 0.1	-50 to +1760	-58 to +3200	IEC584	200°C (360°F)	0.2°C (0.36°F)	±0.01
T	1°C (1.8°F)	± 0.1	-200 to +400	-328 to +752	IEC584	50°C (90°F)	0.05°C (0.09°F)	±0.01
U	1°C (1.8°F)	± 0.1	-200 to +600	-328 to +1112	DIN 43710	75°C (135°F)	0.05°C (0.09°F)	±0.01
WV3	2°C (3.6°F)	± 0.1	0 to +2300	+32 to +4172	ASTM E988-90	200°C (360°F)	0.2°C (0.36°F)	±0.01
WV5	2°C (3.6°F)	± 0.1	0 to +2300	+32 to +4172	ASTM E988-90	200°C (360°F)	0.2°C (0.36°F)	±0.01
Ω	0.1 Ω	± 0.1	0 to 5000 Ω			30 Ω	10 mΩ	±0.01
mV	10 μV	± 0.1	-12 to 800 mV			5 mV	1 μV	±0.01

\*whichever is greater; Total Reference Accuracy = Basic Accuracy + CJ Accuracy (T/C only)

\*\* or 50% of upper range value, whichever is greater

\*\*\* reference temperature 24°C

### OPERATING CONDITIONS

Ambient temperature, rated.....	-40 to 85°C (-40 to 185°F)
Humidity.....	0 to 95% RH (non-cond.)
Vibration.....	Max 4g over 25 to 100Hz
Cold junction accuracy.....	±1.0°C

### ELECTRICAL INPUT SPECIFICATIONS

Supply voltage.....	7.2 to 30 VDC
Power supply voltage effect.....	≤ 0.005% of span per VDC
Warm-up time.....	5 min
Response time (programmable).....	1 to 60 sec
Galvanic isolation.....	1500 VAC

### CURRENT OUTPUT SPECIFICATIONS

Signal output range.....	4 to 20 mA
Update time.....	440 msec
Load resistance (Ω).....	≤(V supply - 7.2) / 0.023 A 0 to 904 Ω

### ALARM LEVELS

Programmable.....	3.5 to 4 mA downscale 20 to 23 mA upscale
NAMUR NE43 Upscale.....	23 mA
NAMUR NE43 Downscale.....	3.5mA

### APPROVALS

#### Observed Authority requirements:

EMC 2004/108/EC

Emmission and immunity ..... EN 61326

ATEX 94/9/EC..... EN 50014, EN 50020

FM, ASCN..... 3600, 3611, 3610

CSA, CAN / CSA..... C22.2 No. 157, E60079-11,  
UL 913

#### Ex / I.S. approval:

KEMA 06 ATEX 0063 X.....  II 1 GD, T80°C...T105°C

Max. amb. Temperature for T4..... 85°C

Max. amb. Temperature for T6..... 60°C

Applicable in zone..... 0, 1, 2, 20, 21 and 22

FM, applicable in..... IS, CL I, DIV 1, Grp. A-D, T4...T6

..... AEx ia IIC

NI, CL I, DIV 2, Grp. A-D, T4...T6

Entity, FM Installation Drawing No..... 50016324

CSA, applicable in..... IS, CL I, DIV 1, Grp. A-D, T4...T6

..... Ex ia IIC, AEx ia IIC

Entity, Installation Drawing No..... 50016326

#### Ex / I.S. data:

U<sub>i</sub> (max)..... 30 VDC

I<sub>i</sub> (max)..... 120 mADC

P<sub>i</sub> (max)..... 0.84 W

L<sub>i</sub> (max)..... 10 μH

C<sub>i</sub> (max)..... 1.0 nF

U<sub>o</sub> (max)..... 9.6 VDC

I<sub>o</sub> (max)..... 25 mADC

P<sub>o</sub> (max)..... 60 mW

L<sub>o</sub> (max)..... 33 mH

C<sub>o</sub> (max)..... 3.6 μF



## STT17H-BS Specifications

Sensor Type	Basic Accuracy*		Rated Range		Standards	Minimum Span**	Temperature Effects per 1.0°C (1.8°F) Change in Ambient Temperature***	
	Fixed	% of Span	°C	°F			Fixed	% of Span
Pt100	0.2°C (0.36°F)	± 0.1	-200 to +850	-328 to +1562	IEC60751	10°C (18°F)	0.01°C (0.018°F)	±0.01
Ni100	0.3°C (0.54°F)	± 0.1	-60 to +250	-76 to +482	DIN 43760	10°C (18°F)	0.01°C (0.018°F)	±0.01
B	1°C (1.8°F)	± 0.1	+400 to +1820	+752 to +3308	IEC584	100°C (180°F)	0.2°C (0.36°F)	±0.01
E	0.5°C (0.9°F)	± 0.1	-100 to +1000	-148 to +1832	IEC584	50°C (90°F)	0.05°C (0.09°F)	±0.01
J	0.5°C (0.9°F)	± 0.1	-100 to +1200	-148 to +2192	IEC584	50°C (90°F)	0.05°C (0.09°F)	±0.01
K	0.5°C (0.9°F)	± 0.1	-180 to +1372	-192 to +2502	IEC584	50°C (90°F)	0.05°C (0.09°F)	±0.01
L	0.5°C (0.9°F)	± 0.1	-100 to +900	-148 to +1652	DIN 43710	50°C (90°F)	0.05°C (0.09°F)	±0.01
N	0.5°C (0.9°F)	± 0.1	-180 to +1300	-292 to +2372	IEC584	50°C (90°F)	0.05°C (0.09°F)	±0.01
R	1°C (1.8°F)	± 0.1	-50 to +1760	-58 to +3200	IEC584	100°C (180°F)	0.2°C (0.36°F)	±0.01
S	1°C (1.8°F)	± 0.1	-50 to +1760	-58 to +3200	IEC584	100°C (180°F)	0.2°C (0.36°F)	±0.01
T	0.5°C (0.9°F)	± 0.1	-200 to +400	-328 to +752	IEC584	50°C (90°F)	0.05°C (0.09°F)	±0.01
U	0.5°C (0.9°F)	± 0.1	-200 to +600	-328 to +1112	DIN 43710	50°C (90°F)	0.05°C (0.09°F)	±0.01
W3	1°C (1.8°F)	± 0.1	0 to +2300	+32 to +4172	ASTM E988-90	100°C (180°F)	0.2°C (0.36°F)	±0.01
W5	1°C (1.8°F)	± 0.1	0 to +2300	+32 to +4172	ASTM E988-90	100°C (180°F)	0.2°C (0.36°F)	±0.01
Ω	0.1 Ω	± 0.1	0 to 7000 Ω			25 Ω	5 mΩ	±0.01
mV	10 μV	± 0.1	-800 to 800 mV			5 mV	0.5 μV	±0.01

\*whichever is greater; Total Reference Accuracy= Basic Accuracy+ CJ Accuracy(T/C only)

\*\*or 50% of upper range value, whichever is greater

\*\*\* reference temperature 24°C

### OPERATING CONDITIONS

Ambient temperature, rated.....	-40 to 85°C (-40 to 185°F)
Humidity.....	0 to 95% RH (non-cond.)
Vibration.....	Max 4g over 25 to 100Hz
Cold junction accuracy.....	±1.0°C

### ELECTRICAL INPUT SPECIFICATIONS

Supply Voltage.....	8 to 35 VDC
Power supply voltage effect.....	≤ 0.005% of span per VDC
Warm-up time.....	30 sec
Response time (programmable).....	1 to 60 sec
Galvanic isolation.....	1500 VAC

### CURRENT OUTPUT SPECIFICATIONS

Signal output range.....	4 to 20 mA
Update time.....	440 msec
Load resistance (Ω).....	≤(V supply - 8) / 0.023 A 0 to 1174 Ω

### ALARM LEVELS

Programmable.....	3.5 to 4 mA down scale 20 to 23 mA up scale
NAMUR NE43 Upscale.....	23 mA
NAMUR NE43 Downscale.....	3.5 mA

### APPROVALS

<b>Observed Authority requirements:</b>	<b>Standard:</b>
EMC 2004/108/EC	
Emmission and immunity .....	EN 61326
ATEX 94/9/EC.....	EN 60079-0, EN 60079-15

### Ex / I.S. approval:

KEMA 06 ATEX 0043 X.....	Ex II 3 GD, T80°C...T105°C EEx nA [L] IIC T4...T6
Applicable in zone.....	2
Max. amb. Temperature for T4.....	85°C
Max. amb. Temperature for T6.....	60°C

Vmax..... 35V





# STT17F-BS Specifications

Sensor Type	Basic Accuracy*		Rated Range		Standards	Temperature Effects per 1.0°C (1.8°F) Change in Ambient Temperature**	
	Fixed	% of reading	°C	°F		Fixed	% of reading
Pt100	0.2°C (0.36°F)	± 0.1	-200 to +850	-328 to +1562	IEC60751	0.01°C (0.018°F)	±0.01
Pt1000	0.2°C (0.36°F)	± 0.1	-200 to +850	-328 to +1562	IEC60751	0.01°C (0.018°F)	±0.01
Ni100	0.3°C (0.54°F)	± 0.1	-60 to +250	-76 to +482	DIN 43760	0.01°C (0.018°F)	±0.01
Cu10	1.3°C (2.3°F)	± 0.1	-50 to +200	-58 to +392	α = 0.00427	0.02°C (0.036°F)	±0.01
B	1°C (1.8°F)	± 0.1	+400 to +1820	+752 to +3308	IEC584	0.2°C (0.36°F)	±0.01
E	0.5°C (0.9°F)	± 0.1	-100 to +1000	-148 to +1832	IEC584	0.05°C (0.09°F)	±0.01
J	0.5°C (0.9°F)	± 0.1	-100 to +1200	-148 to +2192	IEC584	0.05°C (0.09°F)	±0.01
K	0.5°C (0.9°F)	± 0.1	-180 to +1372	-192 to +2502	IEC584	0.05°C (0.09°F)	±0.01
L	0.5°C (0.9°F)	± 0.1	-200 to +900	-328 to +1652	DIN 43710	0.05°C (0.09°F)	±0.01
N	0.5°C (0.9°F)	± 0.1	-180 to +1300	-292 to +2372	IEC584	0.05°C (0.09°F)	±0.01
R	1°C (1.8°F)	± 0.1	-50 to +1760	-58 to +3200	IEC584	0.2°C (0.36°F)	±0.01
S	1°C (1.8°F)	± 0.1	-50 to +1760	-58 to +3200	IEC584	0.2°C (0.36°F)	±0.01
T	0.5°C (0.9°F)	± 0.1	-200 to +400	-328 to +752	IEC584	0.05°C (0.09°F)	±0.01
U	0.5°C (0.9°F)	± 0.1	-200 to +600	-328 to +1112	DIN 43710	0.05°C (0.09°F)	±0.01
W3	1°C (1.8°F)	± 0.1	0 to +2300	+32 to +4172	ASTM E988-90	0.2°C (0.36°F)	±0.01
W5	1°C (1.8°F)	± 0.1	0 to +2300	+32 to +4172	ASTM E988-90	0.2°C (0.36°F)	±0.01
Ω	0.05 Ω	± 0.1	0 to 10000 Ω			2 mΩ	±0.01
mV	10 μV	± 0.1	-800 to 800 mV			0.2 μV	±0.01

\*whichever is greater; Total Reference Accuracy = Basic Accuracy + CJ Accuracy (T/C only)  
 \*\* reference temperature 24°C

## OPERATING CONDITIONS

Ambient temperature, rated..... -40 to 85°C (-40 to 185°F)  
 Humidity..... 0 to 95% RH (non-cond.)  
 Vibration..... Max 4g over 25 to 100Hz  
 Cold junction accuracy..... ±0.5°C

## ELECTRICAL INPUT SPECIFICATIONS

Supply Voltage..... 9 to 30 VDC  
 In FISCO installations..... 9 to 17.5 VDC  
 Consumption..... < 11 mA  
 Warm-up time..... 30 sec  
 Response time (programmable)..... 1 to 60 sec  
 Galvanic isolation..... 1500 VAC  
 Update time..... < 400 msec  
 Execution time, PID controller..... < 200 msec  
 Execution time, analogue input..... < 50 msec

## OUTPUT SPECIFICATIONS

### Foundation™ Fieldbus connection:

Foundation™ Fieldbus version..... ITK 4.6  
 Foundation™ F. capability..... Basic or LAS  
 Foundation™ F. function blocks..... 2 analogue and 1 PID

### Ex / I.S. data:

Unit	Class I, Zone 0, EEx ia IIC, Entity/FISCO			
	IS, Class I, Division 1, Group A, B, C, D, Entity/FISCO			
	Barrier where Po < 0.84 W	Barrier where Po < 1.3 W	Suitable for FISCO systems	Suitable for FISCO systems
Ui	30 VDC	30 VDC	17.5 VDC	15 VDC
Ii	120 mADC	300 mADC	250 mADC	900 mADC
Pi	0.84 W	1.3 W	2.0 W	5.32 W
Li	1 μH	1 μH	1 μH	1 μH
Ci	2.0 nF	2.0 nF	2.0 nF	2.0 nF
T1...T4	Tamb. < 85°C	Tamb. < 75°C	Tamb. < 85°C	Tamb. < 85°C
T5	Tamb. < 70°C	Tamb. < 65°C	Tamb. < 60°C	Tamb. < 60°C
T6	Tamb. < 60°C	Tamb. < 45°C	Tamb. < 45°C	Tamb. < 45°C

## APPROVALS

### Observed Authority requirements: Standard:

EMC 2004/108/EC  
 Emmission and immunity EN 61326  
 ATEX 94/9/EC..... EN 50014, EN 50020, EN 50281-1-1, EN 50284, and IEC 60079-27 (FISCO)  
 FM, ASCN..... 3600, 3611, 3610  
 CSA, CAN / CSA..... C22.2 No. 142, No. 157  
 CAN / CSA..... E60079-0, E60079-11, E60079-15, UL913, UL1604

### Ex / I.S. approval:

KEMA 06 ATEX 0046.....  II 1 GD, T65°C...T105°C  
 EEx ia IIC T4...T6  
 Ex II 2(1) GD, T65oC...T105oC  
 EEx ib [ia] IIC T4...T6  
 Applicable in zone..... 0, 1, 2, 20, 21 or 22  
 FM, applicable in..... IS, CL I, DIV 1, Grp. A-D, T4...T6  
 AEx ia IIC  
 NI, CL I, DIV 2, Grp. A-D, T4...T6  
 Entity, FM Installation Drawing No..... 50016325  
 CSA, applicable in..... IS, CL I, DIV 1, Grp. A-D, T4...T6  
 Ex ia IIC, AEx ia IIC  
 CL I, DIV 2, Grp. A-D, T4...T6  
 Entity, CSA Installation Drawing No..... 50016325

### Ex / I.S. data:

Unit	Class I, Zone 1, EEx ib IIC, Entity/FISCO	
	IS, Class I, Division 2, Group A, B, C, D, Entity/FISCO	
	Barrier where Po < 5.32 W	FISCO segment coupler
Ui	30 VDC	17.5 VDC
Ii	250 mADC	All
Pi	5.32 W	All
Li	1 μH	1 μH
Ci	2.0 nF	2.0 nF
T1...T4	Tamb. < 85°C	Tamb. < 85°C
T5	Tamb. < 75°C	Tamb. < 75°C
T6	Tamb. < 60°C	Tamb. < 60°C

## STT17F-BN Specifications

Sensor Type	Basic Accuracy*		Rated Range		Standards	Temperature Effects per 1.0°C (1.8°F) Change in Ambient Temperature**	
	Fixed	% of reading	°C	°F		Fixed	% of reading
Pt100	0.2°C (0.36°F)	± 0.1	-200 to +850	-328 to +1562	IEC60751	0.01°C (0.018°F)	±0.01
Pt1000	0.2°C (0.36°F)	± 0.1	-200 to +850	-328 to +1562	IEC60751	0.01°C (0.018°F)	±0.01
Ni100	0.3°C (0.54°F)	± 0.1	-60 to +250	-76 to +482	DIN 43760	0.01°C (0.018°F)	±0.01
Cu10	1.3°C (2.3°F)	± 0.1	-50 to +200	-58 to +392	$\alpha = 0.00427$	0.02°C (0.036°F)	±0.01
B	1°C (1.8°F)	± 0.1	+400 to +1820	+752 to +3308	IEC584	0.2°C (0.36°F)	±0.01
E	0.5°C (0.9°F)	± 0.1	-100 to +1000	-148 to +1832	IEC584	0.05°C (0.09°F)	±0.01
J	0.5°C (0.9°F)	± 0.1	-100 to +1200	-148 to +2192	IEC584	0.05°C (0.09°F)	±0.01
K	0.5°C (0.9°F)	± 0.1	-180 to +1372	-192 to +2502	IEC584	0.05°C (0.09°F)	±0.01
L	0.5°C (0.9°F)	± 0.1	-200 to +900	-328 to +1652	DIN 43710	0.05°C (0.09°F)	±0.01
N	0.5°C (0.9°F)	± 0.1	-180 to +1300	-292 to +2372	IEC584	0.05°C (0.09°F)	±0.01
R	1°C (1.8°F)	± 0.1	-50 to +1760	-58 to +3200	IEC584	0.2°C (0.36°F)	±0.01
S	1°C (1.8°F)	± 0.1	-50 to +1760	-58 to +3200	IEC584	0.2°C (0.36°F)	±0.01
T	0.5°C (0.9°F)	± 0.1	-200 to +400	-328 to +752	IEC584	0.05°C (0.09°F)	±0.01
U	0.5°C (0.9°F)	± 0.1	-200 to +600	-328 to +1112	DIN 43710	0.05°C (0.09°F)	±0.01
W3	1°C (1.8°F)	± 0.1	0 to +2300	+32 to +4172	ASTM E988-90	0.2°C (0.36°F)	±0.01
W5	1°C (1.8°F)	± 0.1	0 to +2300	+32 to +4172	ASTM E988-90	0.2°C (0.36°F)	±0.01
$\Omega$	0.05 $\Omega$	± 0.1	0 to 10000 $\Omega$			2 m $\Omega$	±0.01
mV	10 $\mu$ V	± 0.1	-800 to 800 mV			0.2 $\mu$ V	±0.01

\*whichever is greater; Total Reference Accuracy = Basic Accuracy + CJ Accuracy (T/C only)

\*\* reference temperature 24°C

### OPERATING CONDITIONS

Ambient temperature, rated..... -40 to 85°C (-40 to 185°F)

Humidity..... 0 to 95% RH (non-cond.)

Vibration..... Max 4g over 25 to 100Hz

Cold junction accuracy..... ±0.5°C

Reference temperature..... 20 to 28°C

### ELECTRICAL INPUT SPECIFICATIONS

Supply Voltage..... 9 to 32 VDC

Consumption..... < 11 mA

Warm-up time..... 30 sec

Response time (programmable)..... 1 to 60 sec

Galvanic isolation..... 1500 VAC

Update time..... < 400 msec

Execution time, PID controller..... < 200 msec

Execution time, analogue input..... < 50 msec

### OUTPUT SPECIFICATIONS

#### Foundation™ Fieldbus connection:

Foundation™ Fieldbus version..... ITK 4.6

Foundation™ F. capability..... Basic or LAS

Foundation™ F. function blocks..... 2 analogue and 1 PID

### APPROVALS

#### Observed Authority requirements: Standard:

EMC 2004/108/EC

Emmission and immunity EN 61326

ATEX 94/9/EC..... EN 60079-0, EN 60079-15

FM, ASCN..... 3600, 3611

CSA, CAN / CSA..... C22.2 No. 142, No. 213

CAN / CSA..... E60079-0, E60079-15, UL1604

#### Ex / I.S. approval:

KEMA 06 ATEX 0045 X.....  II 3 G

EEx nA [L] IIC T4...T6

Applicable in zone..... 2

FM, applicable in..... NI, CL I, DIV 2, Grp. A-D, T4...T6

FNICO

Entity, FM Installation Drawing No..... 50016325

CSA, applicable in..... CL I, DIV 2, Grp. A-D, T4...T6

CL I, Zone 2,

Ex nA IIC, AEx nA IIC

Entity, CSA, Installation Drawing No..... 50016325

Max. amb. Temperature for T4..... 85°C

Max. amb. Temperature for T6..... 60°C

Vmax..... 32V

Li..... 1  $\mu$ H

Ci..... 2.0 nF

## STT171 Custom Configuration Data Sheet

Customer P.O. Number \_\_\_\_\_

Line Item \_\_\_\_\_

Model Number \_\_\_\_\_

Tag Number (max 15 char) \_\_\_\_\_

Honeywell Sales Order Number \_\_\_\_\_

### Sensor Type:

- Pt100
- Ni100
- Ohms

### Output Values:

4 mA Value:

- \_\_\_\_\_ °C
- \_\_\_\_\_ °F
- \_\_\_\_\_ Ohms

20 mA Value:

- \_\_\_\_\_ °C
- \_\_\_\_\_ °F
- \_\_\_\_\_ Ohms

Response time:

\_\_\_\_\_ (0.33 – 60 sec)

### Output Limits:

- Span (4 to 20 mA)
- Max (3.5 to 23 mA)
- Specify Low \_\_\_\_\_ mA, High \_\_\_\_\_ mA
- NAMUR NE 43 (3.8 to 20.5 mA)

### Sensor Error Action:

- Off
- Specify \_\_\_\_\_ mA
- NAMUR NE 43 upscale (23 mA)
- NAMUR NE 43 downscale (3.5 mA)

## STT173 Custom Configuration Data Sheet

Customer P.O. Number \_\_\_\_\_

Line Item \_\_\_\_\_

Model Number \_\_\_\_\_

Tag Number (max 15 char) \_\_\_\_\_

Honeywell Sales Order Number \_\_\_\_\_

### Sensor Type:

- Pt100
- Ni100

#### Wiring:

- 2-wire
- 3-wire
- 4-wire

- Ohms
- mV

- Type B T/C
- Type E T/C
- Type J T/C
- Type K T/C
- Type L T/C
- Type N T/C
- Type R T/C
- Type S T/C
- Type T T/C
- Type U T/C
- Type W3 T/C
- Type W5 T/C

### Cold Junction Compensation:

- Internal
- External / Pt100
- External / Ni100

### Output Values:

4 mA Value:

- \_\_\_\_\_ °C
- \_\_\_\_\_ °F
- \_\_\_\_\_ mV
- \_\_\_\_\_ Ohms

20 mA Value:

- \_\_\_\_\_ °C
- \_\_\_\_\_ °
- \_\_\_\_\_ mV
- \_\_\_\_\_ Ohms

Response time:

\_\_\_\_\_ (1 – 60 sec)

### Output Limits:

- Span (4 to 20 mA)
- Max (3.5 to 23 mA)
- Specify Low \_\_\_\_\_ mA, High \_\_\_\_\_ mA
- NAMUR NE 43 (3.8 to 20.5 mA)

### Sensor Error Action:

- Off
- Specify \_\_\_\_\_ mA
- NAMUR NE 43 upscale (23 mA)
- NAMUR NE 43 downscale (3.5 mA)

## STT17H Custom Configuration Data Sheet

Customer P.O. Number \_\_\_\_\_

Line Item \_\_\_\_\_

Model Number \_\_\_\_\_

Tag Number (max 15 char) \_\_\_\_\_

Honeywell Sales Order Number \_\_\_\_\_

### Sensor Input:

- Single Sensor
- Duplex Sensor (Average)
- Duplex Sensor (Differential)

### Sensor Type:

- Pt100
- Ni100

#### Wiring:

- 2-wire
- 3-wire
- 4-wire

- Ohms
- mV

- Type B T/C
- Type E T/C
- Type J T/C
- Type K T/C
- Type L T/C
- Type N T/C
- Type R T/C
- Type S T/C
- Type T T/C
- Type U T/C
- Type W3 T/C
- Type W5 T/C

### Cold Junction Compensation:

- Internal
- External / Pt100
- External / Ni100

### Output Values:

4 mA Value:

- \_\_\_\_\_ °C
- \_\_\_\_\_ °F
- \_\_\_\_\_ mV
- \_\_\_\_\_ Ohms

20 mA Value:

- \_\_\_\_\_ °C
- \_\_\_\_\_ °
- \_\_\_\_\_ mV
- \_\_\_\_\_ Ohms

Response time:

\_\_\_\_\_ (1 – 60 sec)

### Output Limits:

- Span (4 to 20 mA)
- Max (3.5 to 23 mA)
- Specify Low \_\_\_\_\_ mA, High \_\_\_\_\_ mA
- NAMUR NE 43 (3.8 to 20.5 mA)

### Sensor Error Action:

- Off
- Specify \_\_\_\_\_ mA
- NAMUR NE 43 upscale (23 mA)
- NAMUR NE 43 downscale (3.5 mA)



**STTF Custom Configuration Data Sheet**

Customer P.O. Number \_\_\_\_\_

Line Item \_\_\_\_\_

Model Number \_\_\_\_\_

Tag Number (max 15 char) \_\_\_\_\_

Honeywell Sales Order Number \_\_\_\_\_

**TRANSDUCER BLOCK PARAMETERS**

**Temperature Units**

- °C
- °F
- mV
- Ohms

**Sensor Input**

- Single Sensor
- Duplex Sensor (Average)
- Duplex Sensor (Differential #1 - #2)

**Sensor Type (Sensor 1, Sensor 2)::**

- |                                 |                                      |
|---------------------------------|--------------------------------------|
| <input type="checkbox"/> Pt100  | <input type="checkbox"/> Type B T/C  |
| <input type="checkbox"/> Ni100  | <input type="checkbox"/> Type E T/C  |
| <input type="checkbox"/> Pt500  | <input type="checkbox"/> Type J T/C  |
| <input type="checkbox"/> Ni100  | <input type="checkbox"/> Type L T/C  |
| <input type="checkbox"/> Cu10   | <input type="checkbox"/> Type N T/C  |
| <b>Wiring:</b>                  | <input type="checkbox"/> Type R T/C  |
| <input type="checkbox"/> 2-wire | <input type="checkbox"/> Type S T/C  |
| <input type="checkbox"/> 3-wire | <input type="checkbox"/> Type T T/C  |
| <input type="checkbox"/> 4-wire | <input type="checkbox"/> Type U T/C  |
| <input type="checkbox"/> Ohms   | <input type="checkbox"/> Type W3 T/C |
| <input type="checkbox"/> mV     | <input type="checkbox"/> Type W5 T/C |

**Cold Junction Compensation:**

- Internal
- External / Pt100 2-w
- External / Ni100 3-w

**Sensor Error Detection:**

**Sensor #1**

- Lead breakage and short circuit detection disable
- Lead breakage and short circuit enable
- Lead breakage detection enable, short circuit detection disable
- Lead breakage detection disable, short circuit detection enable

**Sensor #2**

- Lead breakage and short circuit detection disable
- Lead breakage and short circuit enable
- Lead breakage detection enable, short circuit detection disable
- Lead breakage detection disable, short circuit detection enable

## Model Selection Guide (34-44-16-07)

Model Selection Guides are subject to change and are inserted into the specifications as guidance only. Prior to specifying or ordering a model check for the latest revision Model Selection Guides which are published at: <http://hpsweb.honeywell.com/Cultures/en-US/Products/Instrumentation/ProductModelSelectionGuides/default.htm>

# Honeywell

34-44-16U-07  
Issue 13  
Page 1 of 2

## STT 3000 Temperature Transmitter Series STT170

## Model Selection Guide

### Instructions

- Choose Availability column based on Key Number.
- A dot (•) denotes unrestricted availability.
- Select the desired Key Number based on the desired communications protocol.
- Select options and approvals from Tables.

Key Number    I    II    III    IV    V    VI, options  
 | STT17\_ | - | \_ \_ | - | \_ | - | \_ \_ \_ | - | \_ \_ \_ | - | \_ \_ \_ | - | \_ \_ ' \_ \_ |



### Key Number

Description	Selection	Availability				
4-20mA Output, RTD input	STT171	↓				
4-20mA Output, universal input	STT173		↓			
HART Protocol, 4-20mA output	STT17H			↓		
Digital output, Foundation Fieldbus protocol	STT17F				↓	
Configuration tool for STT171, 173 and 17H	STT17C					↓

**Table I - Safety Approvals**

Approval Body	Approval Type	Location or Classification					
None	No approval body certifications included		00	•	•	•	•
FM, CSA, ATEX	Intrinsically Safe ENTITY	Class I, Div. 1, Groups A,B,C,D, T4 Class I, Zone 0/1; AEx ia IIC, T4	BS	•	•	•	•
	Non-Incendive	Class I, Div. 2, Groups A,B,C,D, T4		•	•	•	•
	Intrinsically Safe ENTITY	Class I, Div. 2, Groups A,B,C,D, T4 Class I, Zone 0/1; Ex ia IIC, T4		•	•	•	•
	* Intrinsically Safe Zone 0/1	Ex II 1 GD, EEx ia IIC, T4..T6 Ex II 2 (1) GD, T4..T6	BN	•	•		
	Non-Incendive Zone 2	Class I, Div. 2, Groups A,B,C,D, T4 Ex II 3 G, EEx nA [L] T4..T6		•	•		

When installed in Field Mount Enclosure Table IV, E \_\_, or T \_\_

FM Approval	Intrinsically Safe ENTITY Non-Incendive	Class I, Div. 1, Groups A,B,C,D, T4 Class I, Zone 0/1; AEx ia IIC, T4 Class I, Div. 2, Groups A,B,C,D, T4	1G	e	e	e	e
CSA	Intrinsically Safe ENTITY Non-Incendive	Class I, Div. 2, Groups A,B,C,D, T4 Class I, Zone 0/1; Ex ia IIC, T4 Class I, Div. 2, Groups A,B,C,D, T4	2G	e	e	e	e
ATEX	* Intrinsically Safe Zone 0/1	Ex II 1 GD, EEx ia IIC, T4..T6 Ex II 2 (1) GD, T4..T6	3S	e	e	e	
	Non-Incendive Zone 2	Class I, Div. 2, Groups A,B,C,D, T4 Ex II 3 G, EEx nA [L] T4..T6	3N				e

\* Ex II GD or II 2 (1) GD allows for installation in potentially explosive atmospheres caused by the presence of combustible dusts only when mounted in a metal enclosure of form B according to DIN 43729 (Head-Mount enclosure) that provides a degree of protection of at least IP 6X in accordance with EN 60529, that is suitable for the application and is correctly installed.

**TABLE II - No Option**

No Option	0	•	•	•	•	•
-----------	---	---	---	---	---	---

**TABLE III - Configuration & Certificates**

Configuration	None - Factory Default Configuration Supplied	0 __	•	•	•	•
	Custom Transmitter Configuration with Printed Report **	T __	•	•	•	•
Calibration	Custom Transmitter Calibration with Printed Report **	C	•	•	•	
Optional Certificates	No Option	_ 0	•	•	•	•
	No Certificate of Conformance/Origin	_ _ 0	•	•	•	•
	Certificate of Conformance/Origin	_ _ R	•	•	•	•

## Model Selection Guide, (34-44-16-07) cont.

		STT17 Selection	Availability				
			1	3	H	F	C
			↓	↓	↓	↓	↓
Housing	No Housing Supplied	0__	•	•	•	•	•
	Field Mount 316 Aluminum with Beige Epoxy Coating	E__	d	d	d	d	
	Mount 316 Stainless Steel	T__	d	d	d	d	
	Head Mt Type 4X housing - Beige	C__	g	g	g	g	
Cable/Conduit Entry	Not Applicable - No Housing Supplied	_0_	•	•	•	•	•
	1/2" NPT Cable/ Conduit Entry	_N_	•	•	•	•	
	M20 x 1.5 Cable/ Conduit Entry	_M_	•	•	•	•	
Integral Meter	No Integral Meter Supplied	__0	•	•	•	•	•
	E.U. Meter for Field Mount Housing	__E	h	h	h		

**TABLE V - Optional Equipment**

Mounting	No mounting bracket	0__	•	•	•	•	•
	Carbon steel pipe mounting bracket for 2" pipe	M__	e	e	e	e	
	Stainless Steel mounting bracket for 2" pipe	S__	e	e	e	e	
	Spring loading mounting set	L__	f	f	f	f	
	DIN rail mounting clip (top hat or G rail)	D__	f	f	f	f	
M20 adaptors	No adaptors required	_0_	•	•	•	•	•
	1 adaptor for M20 x 1.5 wiring entry	_1_	•	•	•	•	
	2 adaptors for M20 x 1.5 wiring entry	_2_	•	•	•	•	
3/4"NPT adaptors	1 adaptor for 3/4"NPT wiring entry	_3_	•	•	•	•	
Lightning Protection	No lightning protection supplied	__0	•	•	•	•	•
	Externally Mountable to Field Mount Housing	__L	•	•	•	•	
	Internal lightning protection	__S	•	•	•	•	

**TABLE VI - Additional Features**

No Selection		00	•	•	•	•	•
Optional Extended Warranty	Additional Warranty - 1 year	W1	•	•	•	•	
Customer Tagging	316 SS Wired-on Customer I.D. Tag (4 lines, 28 chars. per line, customer specified information)	TG	•	•	•	•	b
	316 SS Wired-on Customer I.D. Tag (blank)	TB	•	•	•	•	
Operator's Manual	STT171 Version; English, French, German Language	M1	•				
	STT173 Version; English, French, German Language	M3		•			
	STT17H Version; English, French, German Language	MH			•		
	STT17F Version; English, French, German Language	MF				•	

**RESTRICTIONS**

Restriction Letters	Available Only With		Not Available With	
	Table	Selection	Table	Selection
b	VI	Select only one option from this group		
d	IV	_N_		
e	IV	E__ or T__		
f	IV	0__		
g	IV			0E
h	I	00		
	IV	E__ or T__		

**ACCESSORIES**

	Part Number
DIN rail clip	50017850-001 • • • •

\*\* If Custom Configuration option "T" or the Custom Calibration option "C" is ordered, the configuration or calibration information required must be entered as a note on the order. Any of the following elements can be included, based on the selected model number:

**(STT171, STT173, STT17H)** Tag Number, CJC, Sensor Type, Sensor Wiring, Temperature Units, URV/LRV, Output Range, Output Limits, Sensor Error Action, Response Time.

**(STT17F)** Tag Number, Sensor Type, URV/LRV, Burnout- High or Low, Response Time

**Ordering Example: STT17H-BN-0-000-EN0-000-00**

## Sales and Service

For application assistance, current specifications, pricing, or name of the nearest Authorized Distributor, contact one of the offices below.

### ASIA PACIFIC

Honeywell Process Solutions,  
(TAC) [hfs-tac-support@honeywell.com](mailto:hfs-tac-support@honeywell.com)

#### Australia

Honeywell Limited  
Phone: +(61) 7-3846 1255  
FAX: +(61) 7-3840 6481  
Toll Free 1300-36-39-36  
Toll Free Fax:  
1300-36-04-70

#### China – PRC - Shanghai

Honeywell China Inc.  
Phone: (86-21) 5257-4568  
Fax: (86-21) 6237-2826

#### Singapore

Honeywell Pte Ltd.  
Phone: +(65) 6580 3278  
Fax: +(65) 6445-3033

#### South Korea

Honeywell Korea Co Ltd  
Phone: +(822) 799 6114  
Fax: +(822) 792 9015

### EMEA

Honeywell Process Solutions,  
Phone: + 80012026455 or  
+44 (0)1344 656000

Email: (Sales)

[FP-Sales-Apps@Honeywell.com](mailto:FP-Sales-Apps@Honeywell.com)

or

(TAC)

[hfs-tac-support@honeywell.com](mailto:hfs-tac-support@honeywell.com)

### AMERICA'S

Honeywell Process Solutions,  
Phone: (TAC) 1-800-423-9883 or  
215/641-3610  
(Sales) 1-800-343-0228

Email: (Sales)

[FP-Sales-Apps@Honeywell.com](mailto:FP-Sales-Apps@Honeywell.com)

or

(TAC)

[hfs-tac-support@honeywell.com](mailto:hfs-tac-support@honeywell.com)

**For more information**

To learn more about Temperature Transmitters,  
visit [www.honeywellprocess.com](http://www.honeywellprocess.com)  
Or contact your Honeywell Account Manager

**Process Solutions**

Honeywell  
1250 W Sam Houston Pkwy S  
Houston, TX 77042

Honeywell Control Systems Ltd  
Honeywell House, Skimped Hill Lane  
Bracknell, England, RG12 1EB

Shanghai City Centre, 100 Jungi Road  
Shanghai, China 20061

[www.honeywellprocess.com](http://www.honeywellprocess.com)

34-TT-03-07  
August 2014  
©2014 Honeywell International Inc.

**Honeywell**