



# Aquavx

## Remote Monitoring and Alarm Notification System

User's Manual

9M02-3100-A001-EN



CONNECT. CONTROL. PROTECT.

## Revision History

| VERSION | DATE    | NOTES  |
|---------|---------|--|
| 6.02    |         | Changed some system channel reporting defaults.<br>Added support for 10 physical digital inputs and 2 physical relay outputs.<br>RS-485 supported on-board and settings added to System>Port 2 menu.   |
| 6.04    |         | Changed FTP default setting.   |
| 6.06    |         | RS-485 receiver modifications.<br>Allow end-of-day report to be set as anytime of the day.<br>Added Call on Change modem for analog inputs. A user-defined delta of consecutive readings triggers this alarm.  |
| 6.08    |         | Changes to remote diagnostic handler and modem initialization.   |
| 6.10    |         | Allow Modbus slave device to be set on/offline through the keypad.<br>List of Maintenance options is now circular.   |
| 6.12    |         | Changes to debug menus.  |
| 7.10    |         | Added support for delta change alarm on analog inputs.<br>Added support for flow rate and total flow being reported from analog or digital (pulse) inputs.<br>Added support for relay control to be energize, de-energize or do nothing on transitions into and out of alarm conditions.<br>Added Operator alarms when on-site too long without reporting in |
| A       | 10/2020 | Document rebranded and contact information updated   |

*Any information furnished by Cattron™ and its agents is believed to be accurate and reliable. All specifications are subject to change without notice. Responsibility for the use and application of Cattron products rests with the end user since Cattron and its agents cannot be aware of all potential uses. Cattron makes no warranties as to non-infringement nor as to the fitness, merchantability, or sustainability of any Cattron products for any specific or general uses. Cattron Holdings, Inc., or any of its affiliates or agents shall not be liable for incidental or consequential damages of any kind. All Cattron products are sold pursuant to the Terms and Conditions of Sale, a copy of which will be furnished upon request. When used as a tradename herein, Cattron means Cattron Holdings, Inc. or one or more subsidiaries of Cattron Holdings, Inc. Cattron™, corresponding logos, and other marks are trademarks or registered trademarks of Cattron Holdings, Inc. Other marks may be the property of third parties. Nothing herein provides a license under any Cattron or any third party intellectual property right.*



## Contents

|        |   |    |
|--------|---|----|
| 1      | Introduction.....   | 5  |
| 1.1    | General Operation .....   | 5  |
| 1.1.1  | Acknowledging Alarms .....                                      | 5  |
| 1.1.2  | Store and Forward Buffer .....                                  | 5  |
| 2      | Installation .....  | 6  |
| 2.1    | Enabling Power.....   | 11 |
| 2.2    | SIM Card Installation on a Cellular Modem .....                 | 11 |
| 2.3    | Cellular Signal Strength and Registration.....                  | 11 |
| 2.4    | Connecting to Serial Port 2 for Modbus.....                     | 12 |
| 3      | Navigating the Menu .....                                       | 13 |
| 3.1    | Keypad and Navigating the Menus.....                            | 14 |
| 3.2    | Menu Structure .....  | 15 |
| 4      | Operator Login/Logout .....                                     | 16 |
| 5      | Viewing Channel Data.....                                       | 17 |
| 6      | Viewing Alarms and Cellular Status .....                        | 19 |
| 7      | Viewing the HOME Screen .....                                   | 21 |
| 8      | Armed and Disarmed .....  | 22 |
| 9      | User-Defined Keys .....   | 23 |
| 10     | Viewing Alarm History .....                                     | 24 |
| 11     | Viewing Event History .....                                     | 25 |
| 12     | Scrolling Channel Status.....                                   | 26 |
| 12.1   | Program a Channel to be Included in the Scrolling Screens ..... | 26 |
| 12.2   | Scrolled Channels.....  | 26 |
| 13     | Manually Controlling Relays.....                                | 27 |
| 14     | Programming from the Keypad .....                               | 28 |
| 14.1   | How to Read the Program Screen.....                             | 28 |
| 14.2   | Site Setup .....  | 29 |
| 14.3   | Pump Setup .....  | 31 |
| 14.3.1 | Pump Parameters.....  | 31 |
| 14.4   | Cell Setup .....  | 33 |



|   |    |
|---|----|
| 14.4.1 Cell Parameters .....                  | 33 |
| 14.5 FTP Setup.....                           | 34 |
| 14.5.1 FTP Parameters .....                   | 34 |
| 14.6 Serial Ports 1 and 2 Setup.....          | 35 |
| 14.6.1 Serial Port Parameters .....           | 35 |
| 14.7 Channel Setup .....                      | 37 |
| 14.7.1 System Channel Parameters.....         | 37 |
| 14.7.2 Digital Input Parameters .....         | 39 |
| 14.7.3 Relay Output Parameters .....          | 40 |
| 14.7.4 Analog Input Parameters .....          | 41 |
| 14.7.5 Modbus Digital Input Parameters .....  | 42 |
| 14.7.6 Modbus Analog Input Parameters .....   | 43 |
| 14.7.7 Modbus Digital Output Parameters ..... | 44 |
| 14.7.8 Derived Analog Parameters .....        | 45 |
| 15 Receiving SMS Commands .....               | 46 |
| 15.1 Overview .....                           | 46 |
| 15.2 SMS Commands.....                        | 46 |
| 15.3 Making Configuration Changes .....       | 46 |
| 16 Technical Support .....                    | 61 |
| 17 Certifications .....                       | 62 |
| 18 Glossary .....                             | 63 |
| 18.1 Cell Statuses.....                       | 69 |



## 1 Introduction

Aquavx is the most user-friendly and reliable remote monitoring, reporting and alarm notification system available. Mounted in a NEMA 4X enclosure, Aquavx provides simple programming either locally through the integral keypad and display or remotely via the Aquavx internet-based hosted services.

Installation is made easy, as all wiring connections are made through quick disconnect-type connectors.

### 1.1 General Operation

Aquavx monitors 10 dry contact/digital inputs, four analog inputs, 20 Modbus digital inputs and 30 Modbus analog inputs continuously. Control, either locally or remotely, is available through two relays and eight Modbus digital outputs.

Aquavx reports information to the RemoteIQ hosted-service system based on the following:

- Time interval
- Channels going into/out of alarm conditions
- Daily statistics reported at the end of day

Alarms and Event History can be viewed locally on the Aquavx display, allowing the operator an easy method of determining how the system has been operating over time.

Aquavx supports Operator login/logout, with this information sent immediately to the hosted-service system.

This manual is applicable to firmware versions 6.00 and later.

#### 1.1.1 Acknowledging Alarms

Alarms are automatically acknowledged once the Aquavx hosted-service system has successfully received the data from Aquavx.

Aquavx will continue to send information until the internet hosted-service has successfully received the data.

#### 1.1.2 Store and Forward Buffer

Aquavx has a 390 entry store and forward buffer to save any records that should be sent to the internet hosted-service in the event that communication to the hosted-service has been interrupted for any reason. When communication is re-established, the buffer is sent all at once.

The buffer can be cleared through the Maintenance Menu – either one entry at a time or all entries at once.



## 2 Installation

Aquavx is shipped mounted inside a NEMA 4X enclosure. The dimensions of the enclosure are shown below.

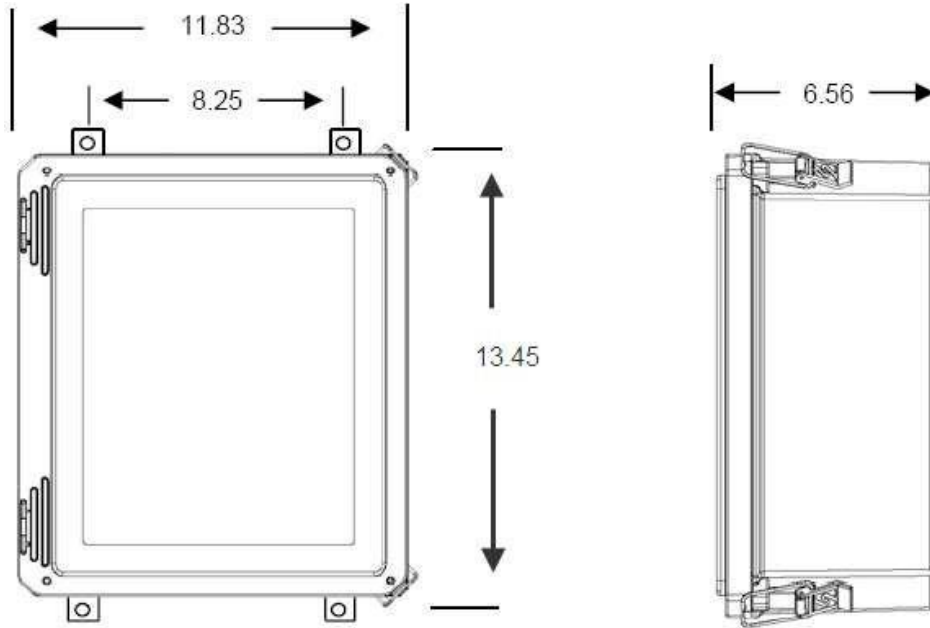

**Figure 1: Panel Mount Mounting Holes**

The connectors for Primary Power, Phone and I/O use quick disconnect plugs. The diagram below shows the location of these connections for the NEMA 4X enclosure.

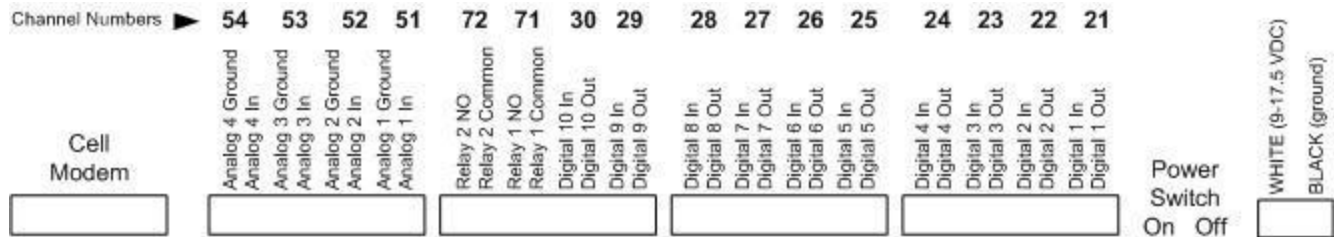

**Figure 2: Field Wiring Diagram**



| Connection Point      | Function  |
|-----------------------|---|
| <b>Power</b>          | Connect the included power connection from the wall-mount power supply to Aquavx. Power requirement is 9-12 VDC.  |
| <b>On/Off</b>         | To supply power to Aquavx, flip the switch. Aquavx will power up and the display will read "RMS Aquavx".  |
| <b>Digital Inputs</b> | <p><b>For Dry Contacts:</b></p> <p>Connect from the 'DIN+' to one side of your dry contact and connect from the DIN# SIG to the other side of your contact.</p> <p><i>For example</i>, DIN1 below is connected to a normally open contact and DIN3 is connected to a normally closed contact.</p> |

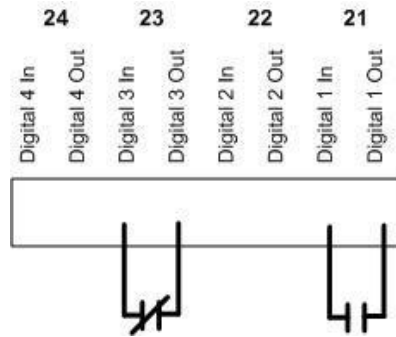

| Connection Point | Function |
|------------------|----------|
|------------------|----------|

**Digital Voltage Inputs**

**For Voltage inputs up to 25 VDC:**

Connect the positive voltage of your input to the DIN# SIG input on Aquavx.  
*For example, DIN3 below is connected to a voltage input.*

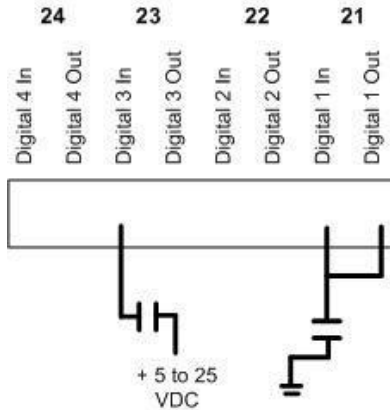

---

**Note:** Do not connect anything to the '+' input.

---



---

**Note:** If the grounds are not already common between your device and Aquavx, connect the "-" signal of the Aquavx power supply to a signal ground on your device.

---

**For Contacts that Close to Ground:**

Jumper the DIN# '+' and DIN# SIG input together. Connect another wire from the DIN# SIG input to the contact that will close to ground.

---

**Note:** Set the channel to Normally Closed.

---





| Connection Point | Function |
|------------------|----------|
|------------------|----------|

**Relay Output**

**Normally Open 0.5 A relay output:**

Connect your device or another interposing relay to the two contacts of the desired relay.

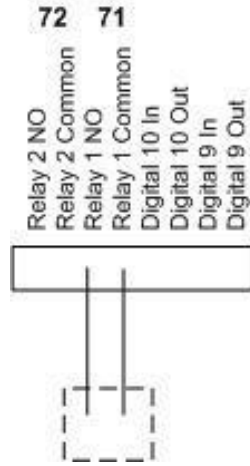

| Connection Point | Function |
|------------------|----------|
|------------------|----------|

**Analog Inputs**

**For Voltage inputs up to 5 VDC:**

Set the Dip Switch for the desired channel to the left, which specifies the input is a voltage input.

Wire the ground or (-) input to the AIN# GND contact.

Wire the voltage or the (+) to the AIN# IN contact.

**For Current inputs up to 20 mA:**

Set the Dip Switch for the desired channel to the RIGHT, which specifies the input is a 4-20 mA input.

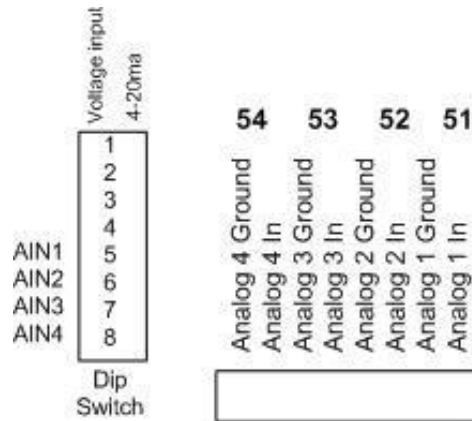

|   |  |
|---|--|
|  | <p><b>CAUTION</b></p> <p>WHEN USING CURRENT INPUTS (0-20 MA OR 4-20 MA):<br/>SET THE DIP SWITCH PRIOR TO CONNECTING ANY WIRES INTO<br/>AQUAVX.<br/>DO NOT APPLY A CURRENT IF THE SWITCH IS SET TO VOLTAGE.</p> |
|---|--|



## 2.1 Enabling Power

Connect the provided DC power supply, or another source of 9 to 17.5 VDC, to the Power connection. Move the On/Off switch to the ON position. Aquavx will start its power-up diagnostics.

Upon completing the power-up diagnostics, Aquavx displays the HOME screen, which shows the current state of Aquavx as well as the date and time.

If the On/Off switch is left ON and there is no DC power being applied, Aquavx will run on battery power. Aquavx can run on battery for 16 hours without DC power and then it will be recharged when DC power is restored.

---

**Note:** If Aquavx is left running on battery for longer than 16 hours, the battery will be drained. It will not be able to be recharged and it will have to be replaced.

---

## 2.2 SIM Card Installation on a Cellular Modem

Aquavx is equipped with an internal cellular modem. A SIM card must be installed for Aquavx to send reports to the hosted-service system. The SIM card is installed in a slot on the side of the cellular modem.

The card is installed with the circuit facing down. Be sure to LOCK the SIM card in place. The SIM should NOT stick out; it should be pushed in far enough to allow the latch to close freely and lock.

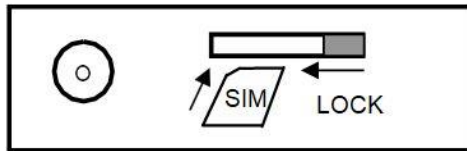

## 2.3 Cellular Signal Strength and Registration

The Cellular signal strength and registration can be viewed by pressing the ENTER key from the HOME (Armed/Disarmed) screen.

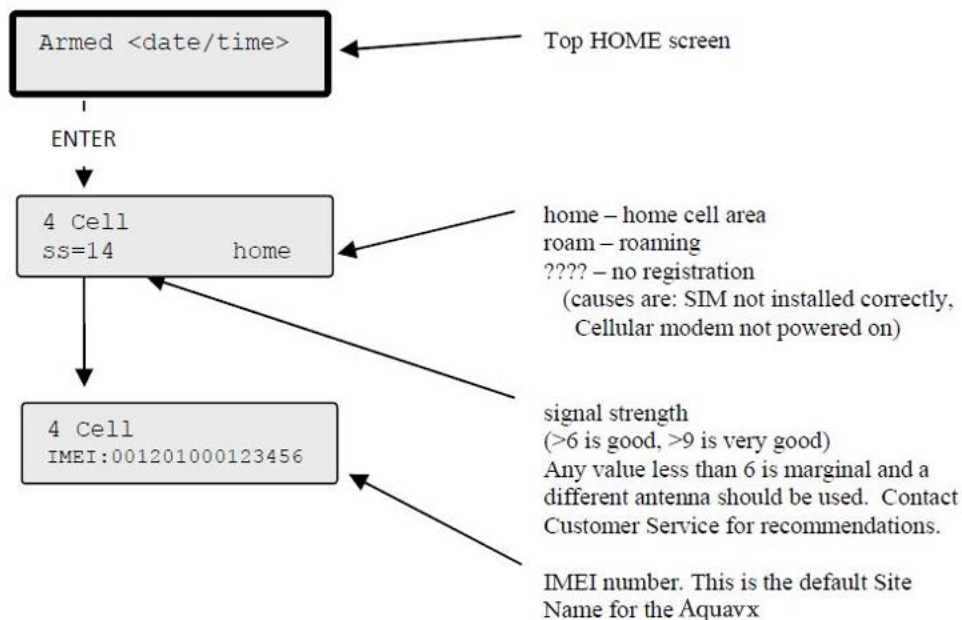

## 2.4 Connecting to Serial Port 2 for Modbus

Serial port 2 is used to communicate to Modbus devices.

Physically, you can connect to serial port 2 via RS-232 using the cable that has a DB9 on one end and a 2x5 rectangular connector on the other. This cable attaches to the Aquavx board at location J1 on the far left-hand side of the board.

Optionally, you can connect via RS-485 using the 3-position terminal block located at J6, next to the J1 connector. Dip Switch position 1 is used to insert a RS-485 terminator into the circuit. Move the switch to the Right or ON position to insert the terminator into the circuit.

You must configure Serial Port 2 from the System menu. Set the port to Master with the appropriate baud rate; the other settings rarely need to be modified from the system defaults, but they are available if they need to be altered for your configuration.



### 3 Navigating the Menu

Navigating the menu structure is much like a cellular phone. The arrow keys are used to navigate between options using the left and right keys and to drill down into an option by pressing the DOWN arrow (↓).

| Key            | Function   |
|----------------|--|
| <b>ENTER</b>   | Accept the current entry.  |
| ←              | Move to the Previous option – on this level.   |
| →              | Move to the Next option – on this level.   |
| ↓              | Menu movement – Move Into this option.<br>In PROGRAMMING – select available option for this parameter. Hold down to cycle faster.  |
| ↑              | In PROGRAMMING – select available option for this parameter. Hold down to cycle faster.  |
| <b>Program</b> | Enter PROGRAMMING for this option.   |
| <b>Control</b> | Relay On/Off Control and Operator In/Out Control.  |
| <b>Clear</b>   | Single press erases the previous character.<br>Holding down erases the entire entry.   |
| <b>HOME</b>    | Move Up a level.   |
| <b>Arm/Dis</b> | Arm and Disarm Aquavx from reporting to the hosted-services.   |
| <b>A-Z</b>     | In PROGRAMMING – cycle through upper-case alphabet. Hold down to cycle faster.   |
| <b>a-z</b>     | In PROGRAMMING – cycle through lower-case alphabet. Hold down to cycle faster.   |
| <b>0-9</b>     | In PROGRAMMING – cycle through numbers, period and minus sign. Hold down to cycle faster.  |
| <b>Symbols</b> | In PROGRAMMING – cycle through available symbols. Hold down to cycle faster.   |
| <b>f1-f3</b>   | User-defined keys. Press and hold down while on any screen in the entire menu system to save it as the function of the key. When pressed again, Aquavx will display that screen and jump to that portion of the menu system. |



### 3.1 Keypad and Navigating the Menu

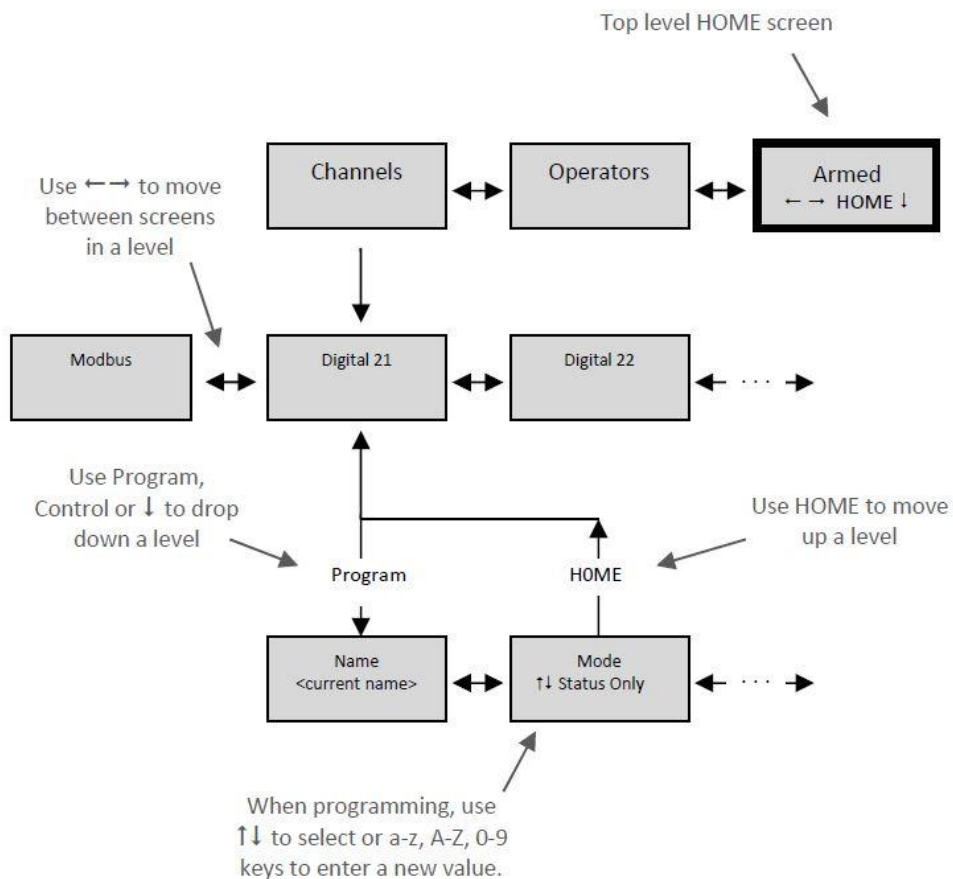

### 3.2 Menu Structure

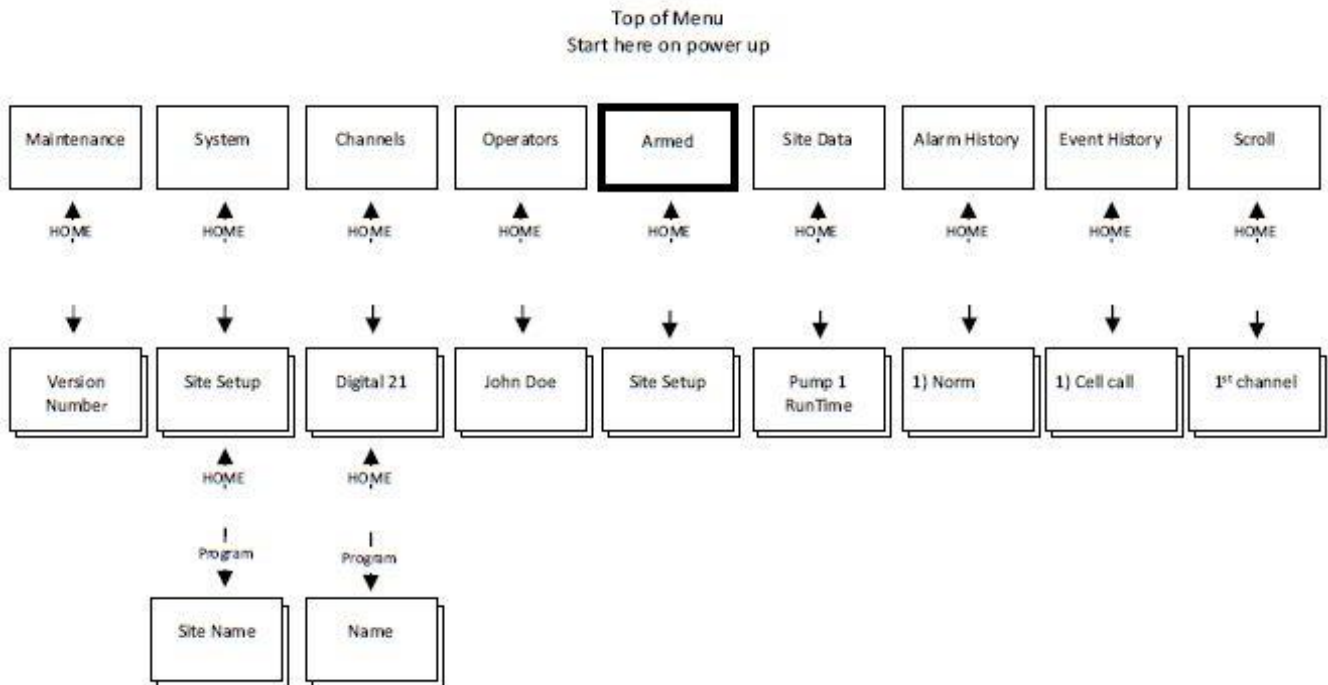

## 4 Operator Login/Logout

To assist in keeping track of who and when personnel are on-site, Aquavx provides an Operator Login/Logout screen. This not only provides validation of on-site visits, but it can act as a lone-man or man-down system as well.

Aquavx immediately reports both Login and Logout actions to the internet hosted-services.

To Login when arriving on a site:

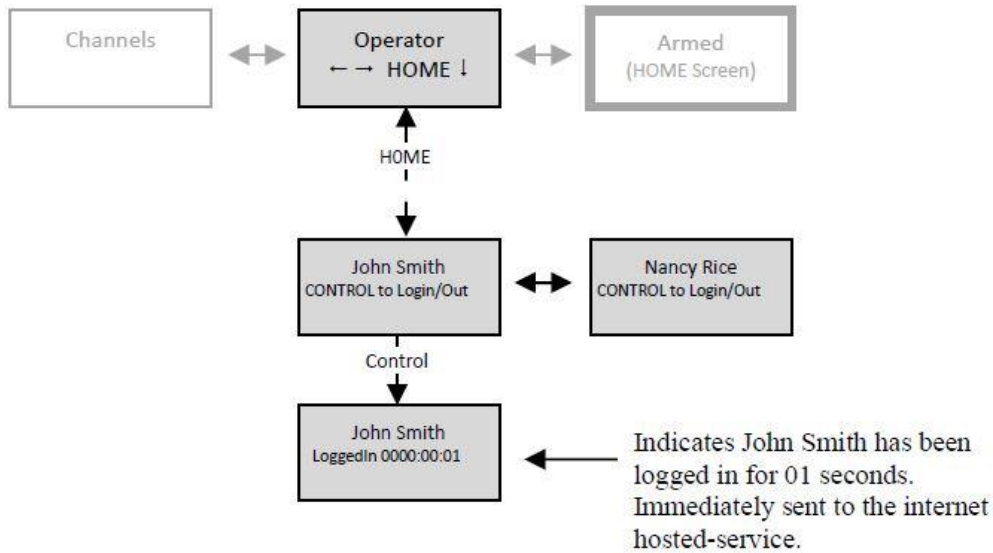

To Logout when leaving a site:

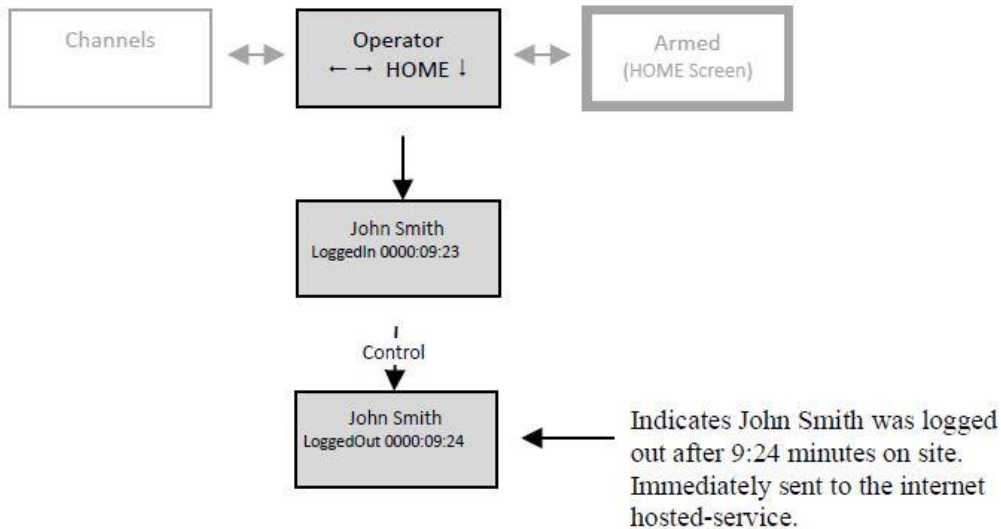



## 5 Viewing Channel Data

There are two methods available to view channel data, as follows:

- Automatically using the Scrolling feature
- Manually selecting a desired channel

For each channel being viewed, the current value is displayed first. To view more detailed information about a channel, press the DOWN arrow (↓) key.

The following shows the type of information available for each channel type that can be accessed by repeatedly pressing the DOWN arrow once viewing the desired channel.

The DOWN arrow can also be used from the Scrolling screen to view more detailed information.

|                        | Digital<br>(system, physical and Modbus) |  | Analog<br>(physical, Modbus and derived) |   |
|------------------------|--|--|--|---|
| 1 <sup>st</sup> screen | State                                    | Normal, Alarm  | State                                    | Normal, Low, High                                 |
| 2 <sup>nd</sup> screen | Value                                    | Current value  | Value                                    | Current value                                     |
| 3 <sup>rd</sup> screen | Min cycle                                | Minimum time in the non-normal state during a single cycle today (*) | High limit                               | Current setting for the high limit                |
| 4 <sup>th</sup> screen | Max cycle                                | Maximum time in the non-normal state during a single cycle today (*) | Low limit                                | Current setting for the low limit                 |
| 5 <sup>th</sup> screen | Duration Limit                           | Current setting for the duration (run-time) limit (*)                | Min                                      | Minimum value for today                           |
| 6 <sup>th</sup> screen | Count Limit                              | Current setting for the count (cycle) limit (*)                      | Max                                      | Maximum value for today                           |
| 7 <sup>th</sup> screen | Duration                                 | Total time in the non-normal state for today (*)                     | Total                                    | Totalized value for today; added every second (*) |
| 8 <sup>th</sup> screen | Count                                    | Total number of counts (cycles) for today (*)                        |  |   |

Continuing to press the DOWN arrow cycles the screen back to the top of the list of details.

(\*) – Not available on Modbus Channels



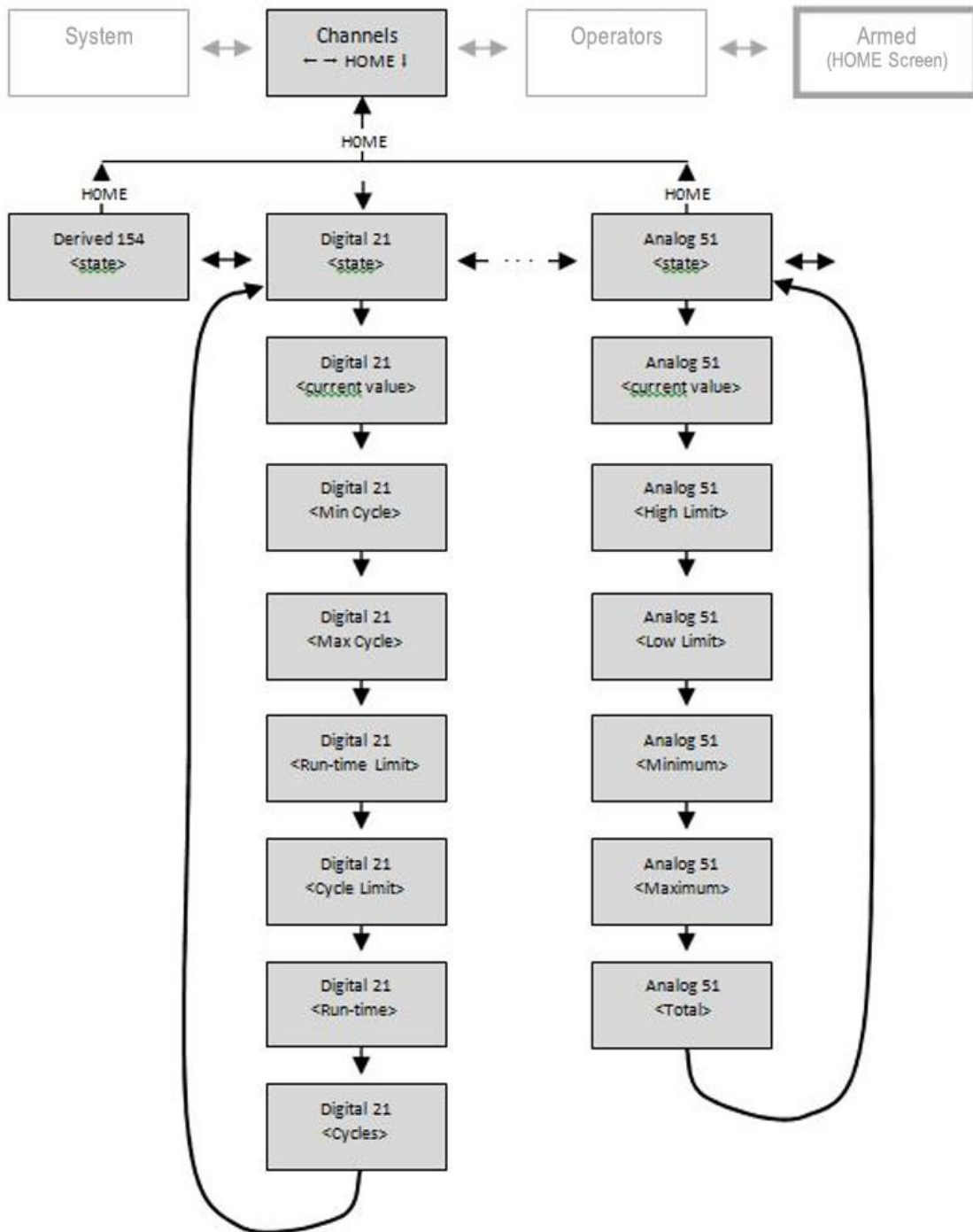

## 6 Viewing Alarms and Cellular Status

To View Alarms and Cell status from the HOME (Armed/Disarmed) screen, press the ENTER key.

When Alarms are active, the HOME screen displays **Alms** in the bottom right-hand corner of the screen. To view active alarms, press the ENTER key. To view additional details about the alarm, continue to press the DOWN arrow (↓) key.

Press the HOME key to move back up the menus, or the UP/DOWN arrow (↑/↓) keys to move between detail screens.

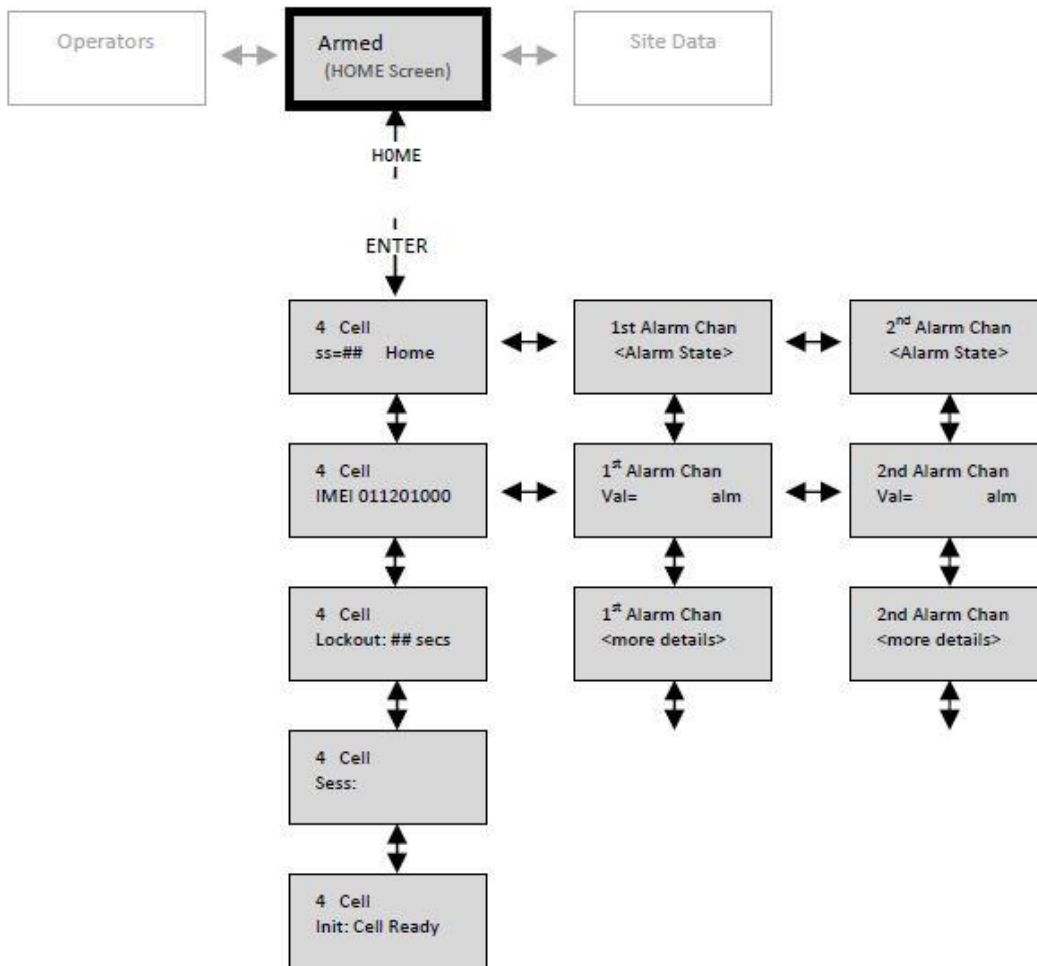

Alarm conditions include the following:

| Alarm State   | Meaning  |
|---|--|
| <b>Digital Channels (physical, system and Modbus)</b> |  |
| notnorm   | Input is in the Not Normal state for less than the Alarm Delay time specified for this channel.  |
| alm   | Input has been in the Not Normal state for more than the Alarm Delay period.   |
| run   | A Run (duration) Alarm exists since the input has been in the Not Normal state for longer than the Duration Limit during this day. (Not available on Modbus).            |
| starts  | A Counts (start) Alarm exists since the input has moved from the Normal to Not Normal state more times than the Counts Limit during this day. (Not available on Modbus). |
| <b>Analog Channels (physical, derived and Modbus)</b> |  |
| lo  | Input has been below the Low Limit for longer than the Alarm Delay.  |
| hi  | Input has been above the High Limit for longer than the Alarm Delay.   |
| fsafe   | Input has been either above the High Fail Safe or below the Low Fail Safe for longer than the Alarm Delay.   |
| notnorm   | Input is in the Not Normal state for less than the Alarm Delay time specified for this channel.  |



## 7 Viewing the HOME Screen

The HOME screen is reached anytime by pressing the HOME key repeatedly, or upon power-up.

The HOME screen displays the current state (armed or disarmed), any alarms that are active and the state of the serial port communications.

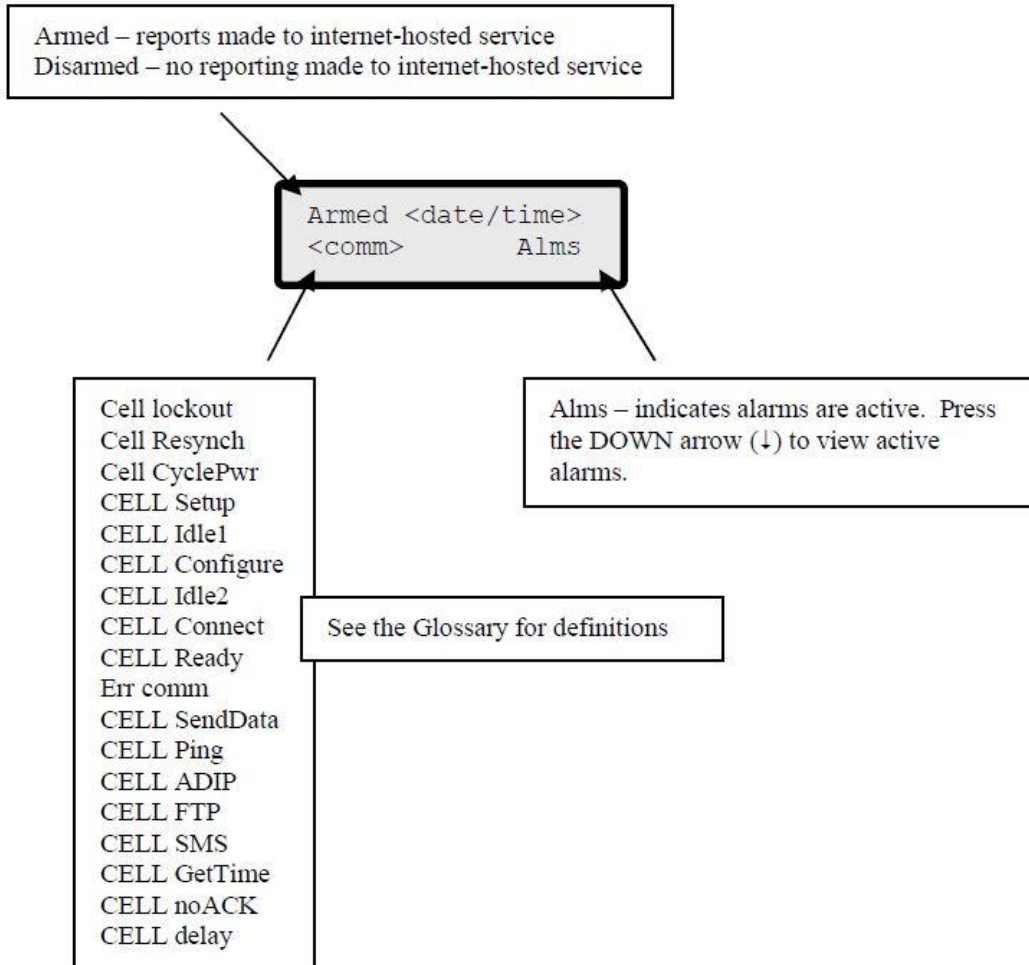

## 8 Armed and Disarmed

Aquavx can be manually Disarmed to prohibit reports to internet hosted-services and prohibit controls from being activated.

When Aquavx is Armed, all channels are monitored, compared to any user-defined limits and if violated, a report is immediately sent to the internet hosted-services for alarm notification reporting.

If Aquavx is left Disarmed, it will automatically switch back to being Armed after 60 minutes.



The following table shows which operations are suspended when Aquavx is Disarmed.

| Function                            | Armed | Disarmed |
|-------------------------------------|-------|----------|
| All channels monitored              | ✓     | ✓        |
| Monitored values compared to limits | ✓     | ✓        |
| Computations performed              | ✓     | ✓        |
| Alarms created and reported         | ✓     | ✗        |
| Relays activated automatically      | ✓     | ✗        |
| Relays activated manually           | ✓     | ✓        |

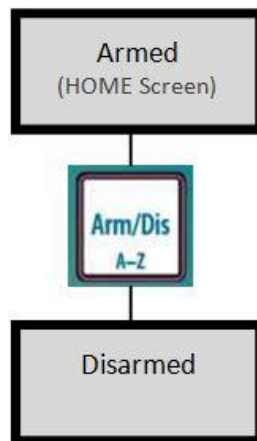
To toggle between Aquavx being Armed and Disarmed, press the Arm/Dis key. The HOME screen changes as shown.



## 9 User-Defined Keys

Aquavx has three user-defined function keys    that are configurable by the user for “quick-access” to any desired screen. The keys are programmed much like buttons on car radios; when the desired screen is being displayed, press and hold the desired f-key for several seconds.

To use the f-key, press it anytime to move directly to the screen programmed.

**For example**, if John Smith was the third person on the Operator list, he could program f3 to immediately bring up the screen for him to Login.

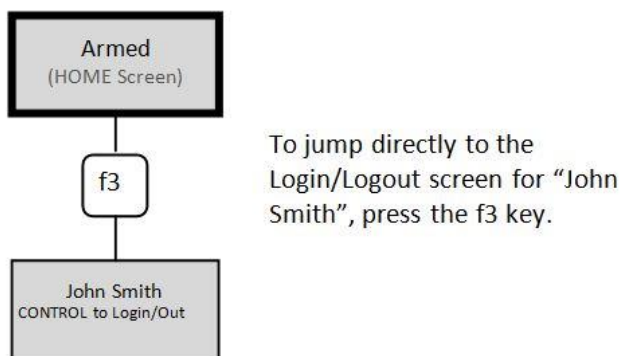
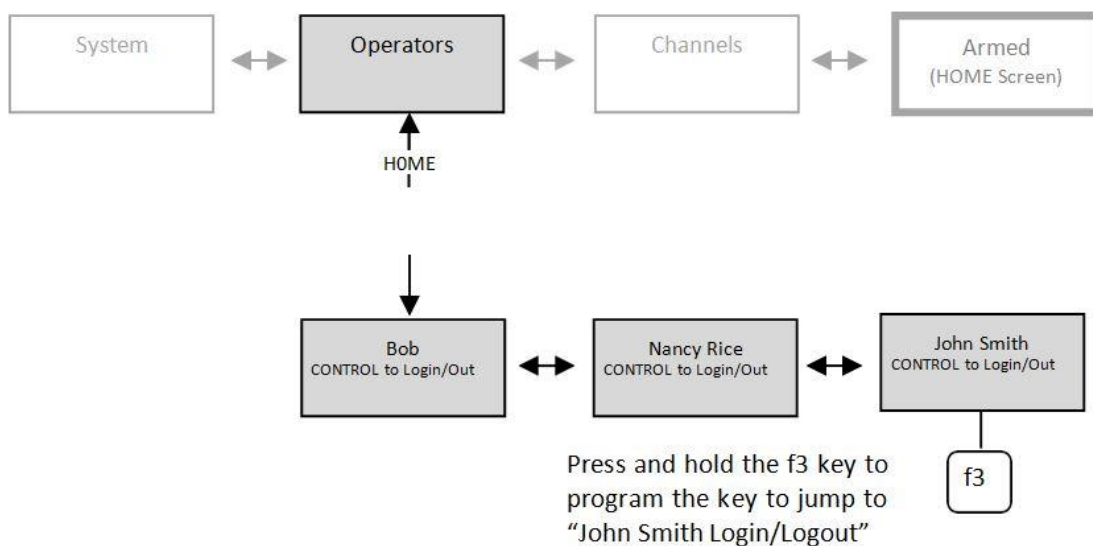

## 10 Viewing Alarm History

Aquavx stores the last 80 alarms that occurred in a local non-volatile log that can be viewed via the Alarm History display.

The Alarm History contains all alarm and return to normal events. This allows the operator an easy method to view the history of recent alarms to assist in determining station operation.

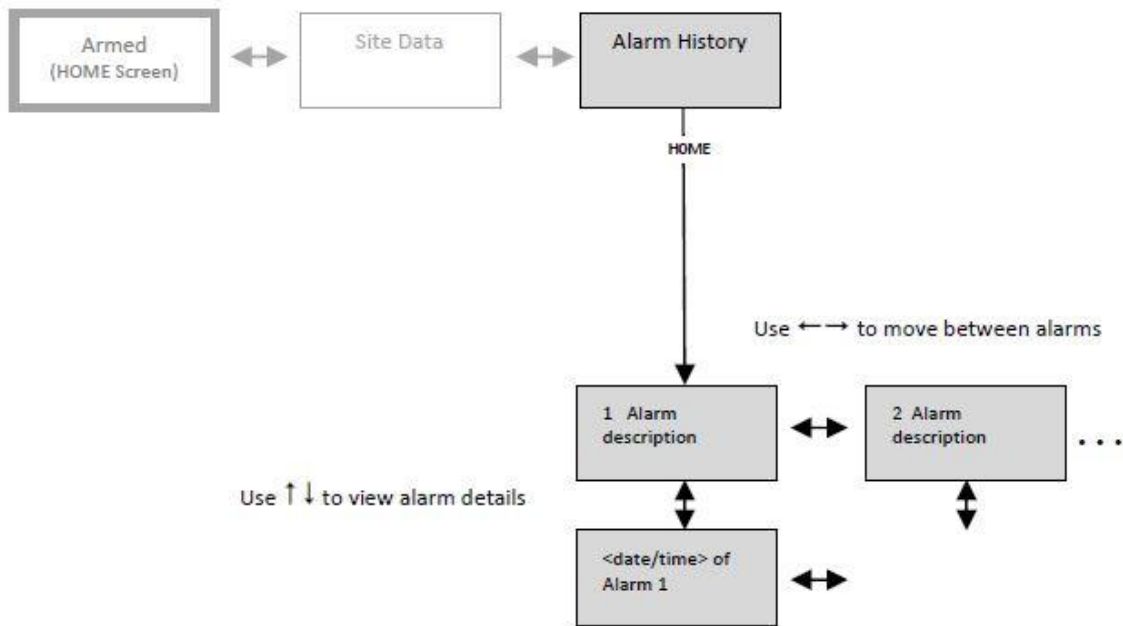



## 11 Viewing Event History

Aquavx stores the last 200 events that occurred in a local non-volatile log that can be viewed via the Event History display.

The Event History contains details on Cell communication, power up and down, and reasons for records being sent to the internet hosted-services.

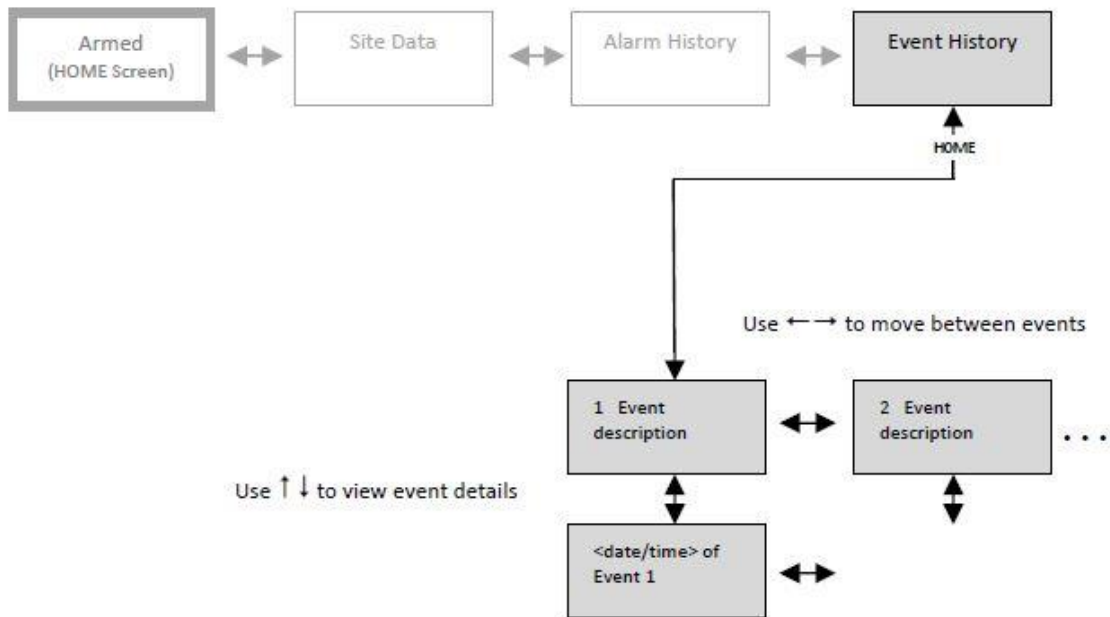

## 12 Scrolling Channel Status

Aquavx has a Scrolling Channel Status screen feature that allows the user to select any channels to be automatically cycled, providing the viewer with a quick method to view the status of channels without having to select any functions.

Channels are selected to appear in the Scrolling Channel Status (Scrolling) screen when programming a Channel.

Once channels are selected and there has been no keypad presses for 60 seconds, Aquavx will automatically start displaying the current status of each channel in order.

### 12.1 Program a Channel to be Included in the Scrolling Screens

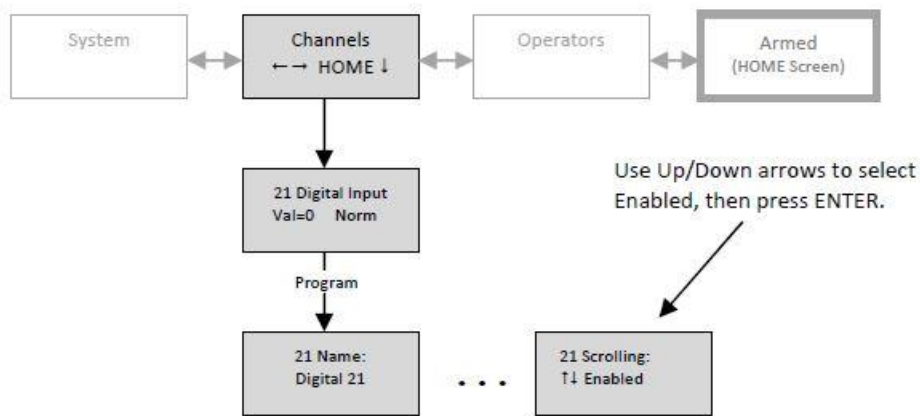

### 12.2 Scrolled Channels

After 60 seconds on the HOME screen without any key pressed, the Scrolling screen is automatically displayed.

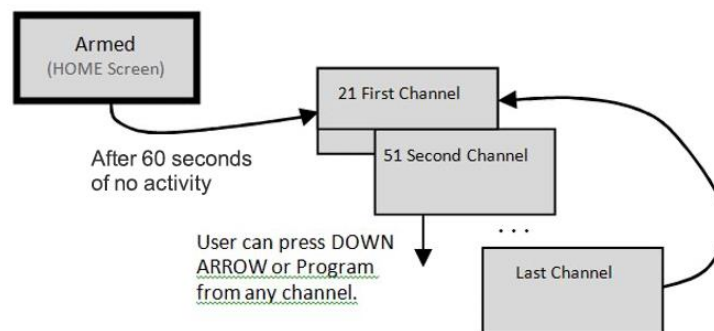

### 13 Manually Controlling Relays

Aquavx can control up to two physical relays and up to eight Modbus relays (coils). Once these channels (71-72 for physical or 151-158 for Modbus) have been programmed, these relays can be manually controlled by pressing the Control key while viewing the desired channel.

The channel can be viewed from either the Scroll display or from the Channels menu.

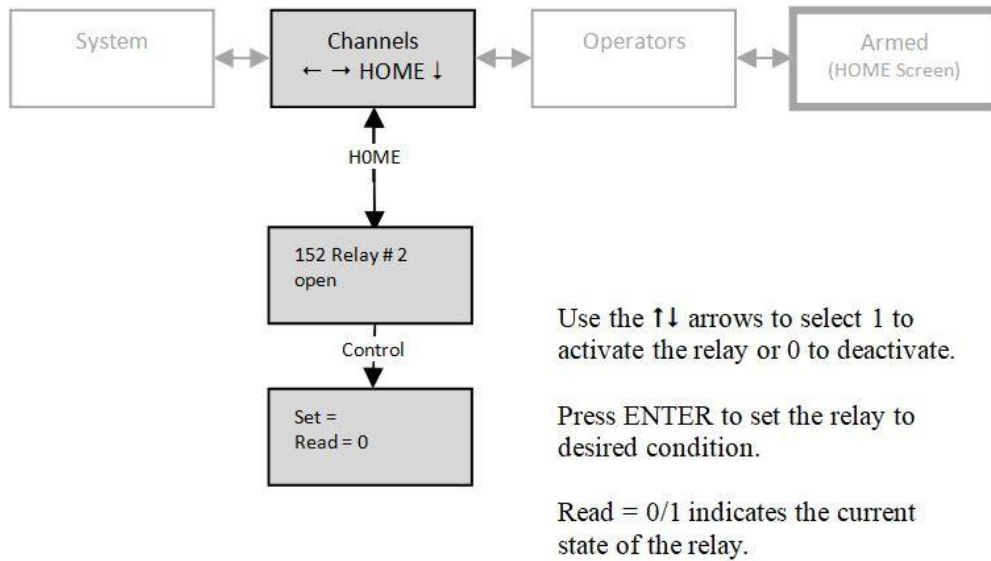

The relays can also be reached directly from the HOME menu by pressing the Control key.

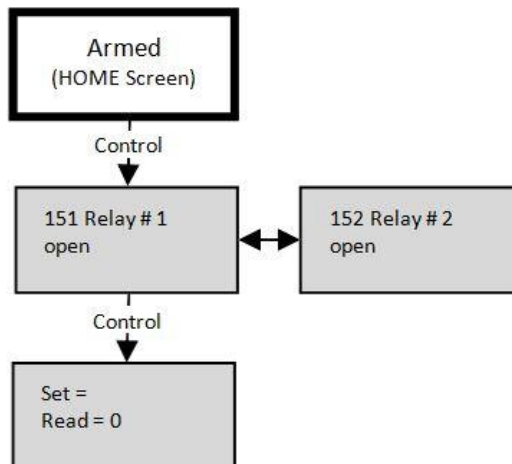

## 14 Programming from the Keypad

In addition to being programmable from the internet hosted-services system, Aquavx can be programmed from the front panel by pressing the keypad to access the various portions of the system.

To enter into programming, move to the Menu option desired and press the Program key. For example, to program a channel, do the following:

1. Move to the Menu option "Channels".
2. Press the DOWN arrow (↓) to move into the actual channels.
3. Use the LEFT (←) and RIGHT (→) arrow keys to select the desired channel.
4. Press the Program key to see the available program parameters.

---

**Note:** Certain parameters are *Protected* from being changed by a Key Access Code. If a parameter needs to be changed that is protected by this code, please contact Cattron at [www.cattron.com/contact](http://www.cattron.com/contact) for assistance.

---

### 14.1 How to Read the Program Screen

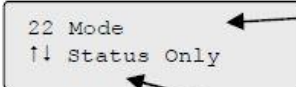

```
22 Mode
↑↓ Status Only
```

Channel number and Parameter to view/set

Current setting. e.g. Status Only

Use arrows to cycle through available settings.

Hold arrow key down to cycle faster.  
Press ENTER key to save the setting.

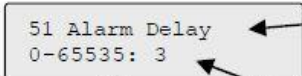

```
51 Alarm Delay
0-65535: 3
```

Channel number and Parameter to view/set

Current value of the parameter.

Range of valid values.  
e.g. Alarm Delay is currently set to 3 seconds

Use A-Z, a-z, 0-9 and Symbol keys to enter values.



## 14.2 Site Setup

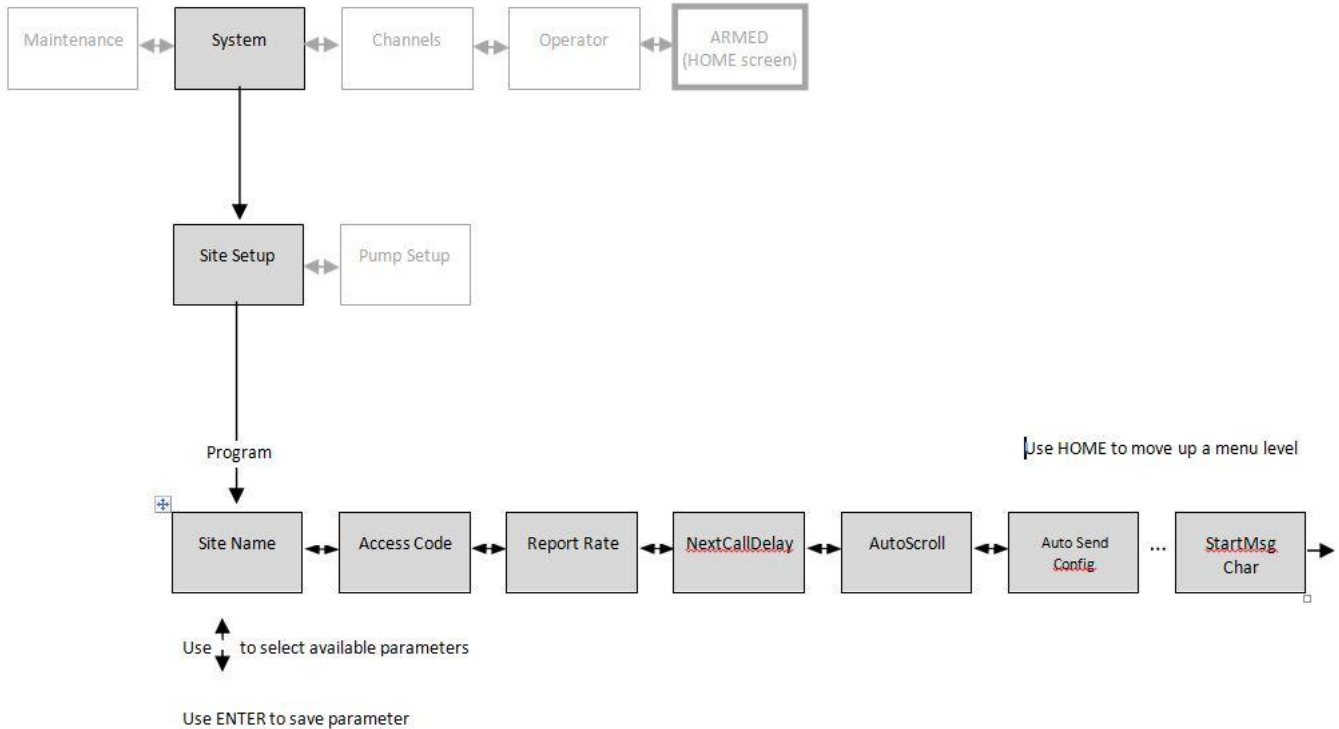

The Site Setup section allows the user to program the following:

| Parameter                      | Description  |
|--------------------------------|--|
| <b>Site Name</b>               | Name of this specific site. Used to uniquely identify this site to the internet hosted-services system. <i>Protected.</i>  |
| <b>Access Code</b>             | A four digit value to limit access to all programming and control functions.   |
| <b>Report Rate</b>             | 1-1440 minutes. Frequency of the Periodic Report to the hosted-services. <i>Protected</i>  |
| <b>Next Call Delay</b>         | 5-3600 seconds. Amount of time to wait between successive calls to the hosted-services. Minimizes the network traffic.   |
| <b>Auto Scroll</b>             | <b>Selections:</b> <i>disable, enable.</i> Turn on or off the scrolling display that automatically cycles through the user-selected channels after no keypad activity for 60 seconds.  |
| <b>Auto Send Configuration</b> | <b>Selections:</b> <i>disable, enable.</i> Automatically sends the entire Aquavx configuration to the internet hosted-services system whenever a change is made to any settings. The configuration is sent 15 minutes after the last change is made. This enables the hosted-services system to always be in sync with Aquavx. |
| <b>Time Zone</b>               | <b>Selections:</b> <i>GMT, Atlantic, Eastern, Central, Mountain, Pacific, Alaska, Hawaii.</i>  |
| <b>Daylight Saving</b>         | <b>Selections:</b> <i>disable, enable.</i> Aquavx automatically adjusts its time for daylight saving. Only affects the local display, not the date/time reported to the internet hosted-services.  |
| <b>Set Date/Time</b>           | Manual method to enter the date/time. Typically not used as Aquavx will automatically set the time nightly from time servers.  |



| Parameter                  | Description   |
|----------------------------|---|
| <b>Dampen ADC</b>          | <b>Selections:</b> <i>disable, enable</i> . Averages the analog input readings on the physical input channels 51-54 to smooth out noisy signals.        |
| <b>Add Checksum</b>        | <b>Selections:</b> <i>disable, enable</i> . Adds the checksum to the end of all reports sent to the internet hosted-services system. <i>Protected</i> . |
| <b>RainFall</b>            | <b>Selections:</b> <i>disable, enable</i> . Enables computing rainfall totals from a rain fall meter attached to digital input 28. <i>Protected</i> .   |
| <b>PumpMethod2</b>         | <b>Selections:</b> <i>disable, enable</i> . Enables computing station flow totals based on pump run-times. <i>Protected</i> .                           |
| <b>Delimiter Character</b> | Field delimiter character used in the protocol between Aquavx and the internet hosted-services. Entered in decimal. <i>Protected</i> .                  |
| <b>Start Msg Character</b> | Start Message character used in the protocol between Aquavx and the internet hosted-services. Entered in decimal. <i>Protected</i> .                    |
| <b>End of Day</b>          | Enter the time during the day to send the End of Day report. The previous 24 hours make up the day of data that is reported. <i>Protected</i> .         |



### 14.3 Pump Setup

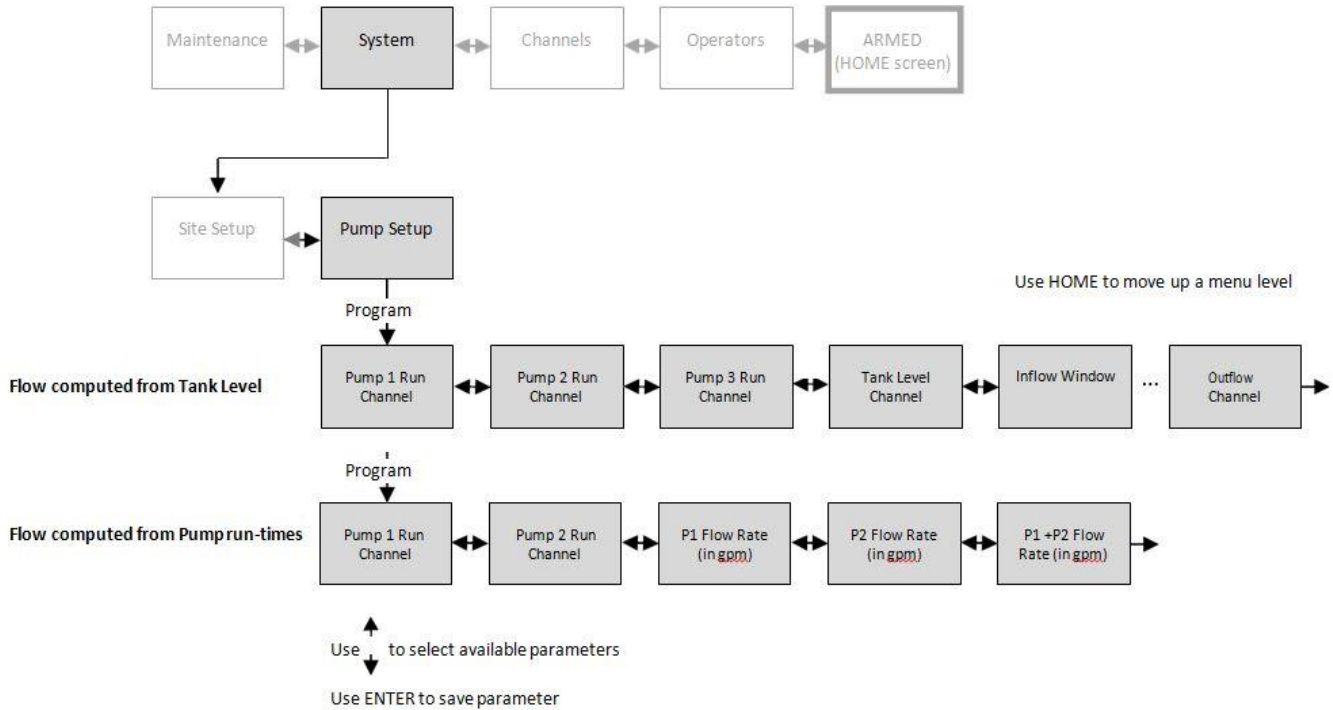

#### 14.3.1 Pump Parameters

Aquavx can compute Flow through the station in two different ways: from the Tank Level and from the pump run-times.

The Pump Setup section allows the user to program the following:

| Parameter   | Description   |
|---|---|
| <b>Pump 1 Run Channel</b>   | The Channel number that is used to monitor the run-time for each of up to three pumps. These are typically channels 21, 22 and 23.  |
| <b>Pump 2 Run Channel</b>   |   |
| <b>Pump 3 Run Channel</b>   |   |
| <i>If the flow is computed from the Tank Level, the follow screens are shown:</i> |   |
| <b>Tank Level Channel</b>   | The Channel number that monitors the Tank Level. This is typically physical analog channel 51, but it could be a Modbus channel.  |
| <b>Inflow Window</b>  | The inflow window specifies an amount of time Aquavx monitors the inflow to determine the Inflow Rate that is used in the volumetric calculation. This time must be less than the amount of time between turning all pumps off and turning a pump back on. Specified (in seconds) from 15 to 300. |
| <b>Tank Section Area</b>  | Surface area of the tank (in square feet).  |
| <b>Inflow Channel</b>   | The Channel number to receive the derived (computed) Inflow Rate. This channel is typically 171.  |



| Parameter   | Description   |
|---|---|
| <b>Outflow Channel</b>  | The Channel number to receive the derived (computed) Outflow Volume. This channel is typically 172. |
| <i>If the flow is computed from pump run-times, the follow screens are shown:</i> |   |
| <b>P1 Flow Rate</b>   | The rate (in gpm) when only pump 1 is running.  |
| <b>P2 Flow Rate</b>   | The rate (in gpm) when only pump 2 is running.  |
| <b>P1+P2 Flow Rate</b>  | The rate (in gpm) when both pump 1 and pump 2 are running.  |





## 14.4 Cell Setup

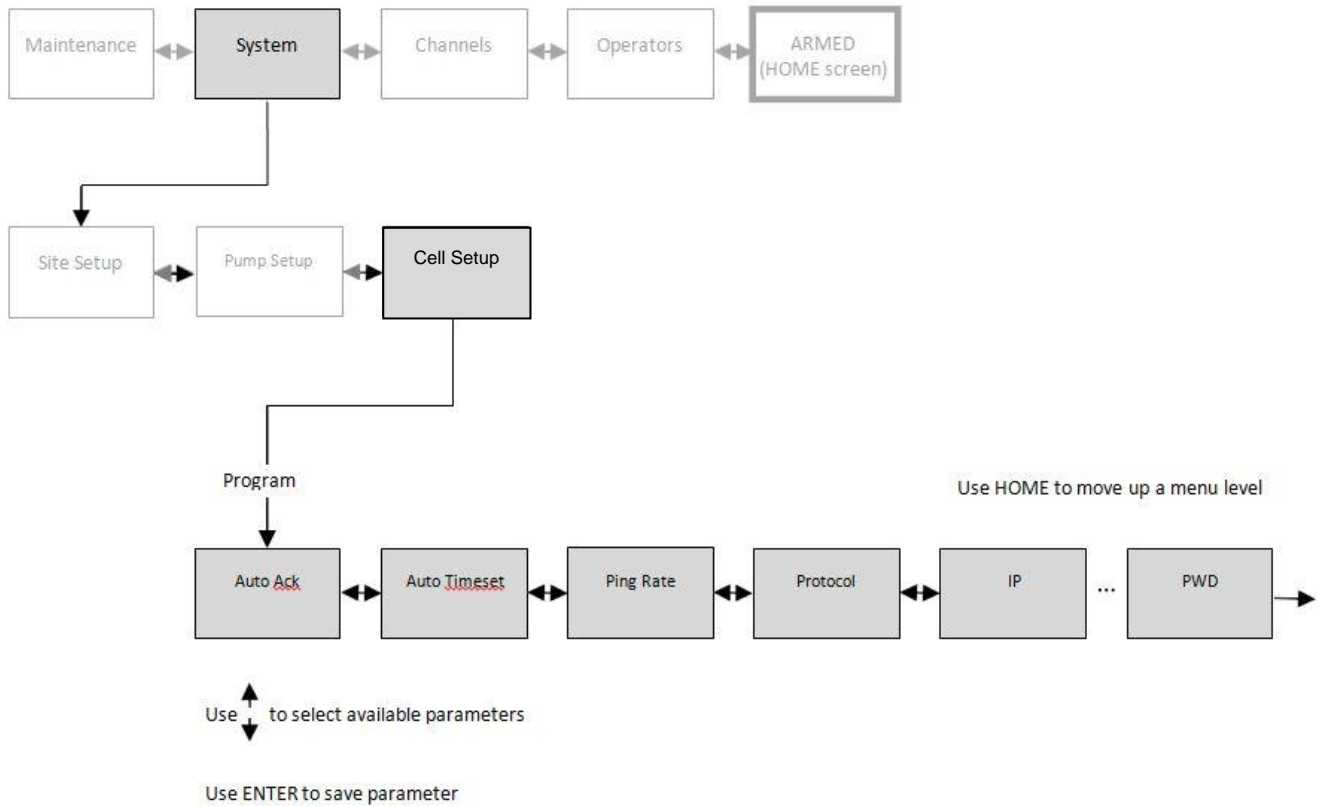

### 14.4.1 Cell Parameters

The Cell Setup configures communication from Aquavx to the internet hosted-services via the Cellular network. The Cell Setup section allows the user to program the following:

| Parameter               | Description   |
|-------------------------|---|
| <b>AutoACK</b>          | <b>Selections:</b> <i>none, demand, auto</i> . Evert report is to be acknowledged from the internet hosted-services. <i>Protected</i> . |
| <b>Auto Timeset</b>     | <b>Selections:</b> <i>disabled, enabled</i> . Time is automatically set via timeservers. <i>Protected</i> .                             |
| <b>Ping Rate</b>        | Frequency to send a Ping packet. 0–1440 minutes. <i>Protected</i> .   |
| <b>Protocol</b>         | <b>Selections:</b> <i>UDP, TCP</i> . <i>Protected</i> .   |
| <b>Port</b>             | 0-65535. <i>Protected</i> .   |
| <b>IP</b>               | DNS or IP number. <i>Protected</i> .  |
| <b>Service Provider</b> | <b>Selections:</b> <i>KORE, T-Mobile, AT&amp;T</i> . <i>Protected</i> .   |
| <b>APN</b>              | Enter the APN for the Service Provider. <i>Protected</i> .  |
| <b>USR</b>              | Enter a username if needed. <i>Protected</i> .  |
| <b>PWD</b>              | Enter a password if needed. <i>Protected</i> .  |



## 14.5 FTP Setup

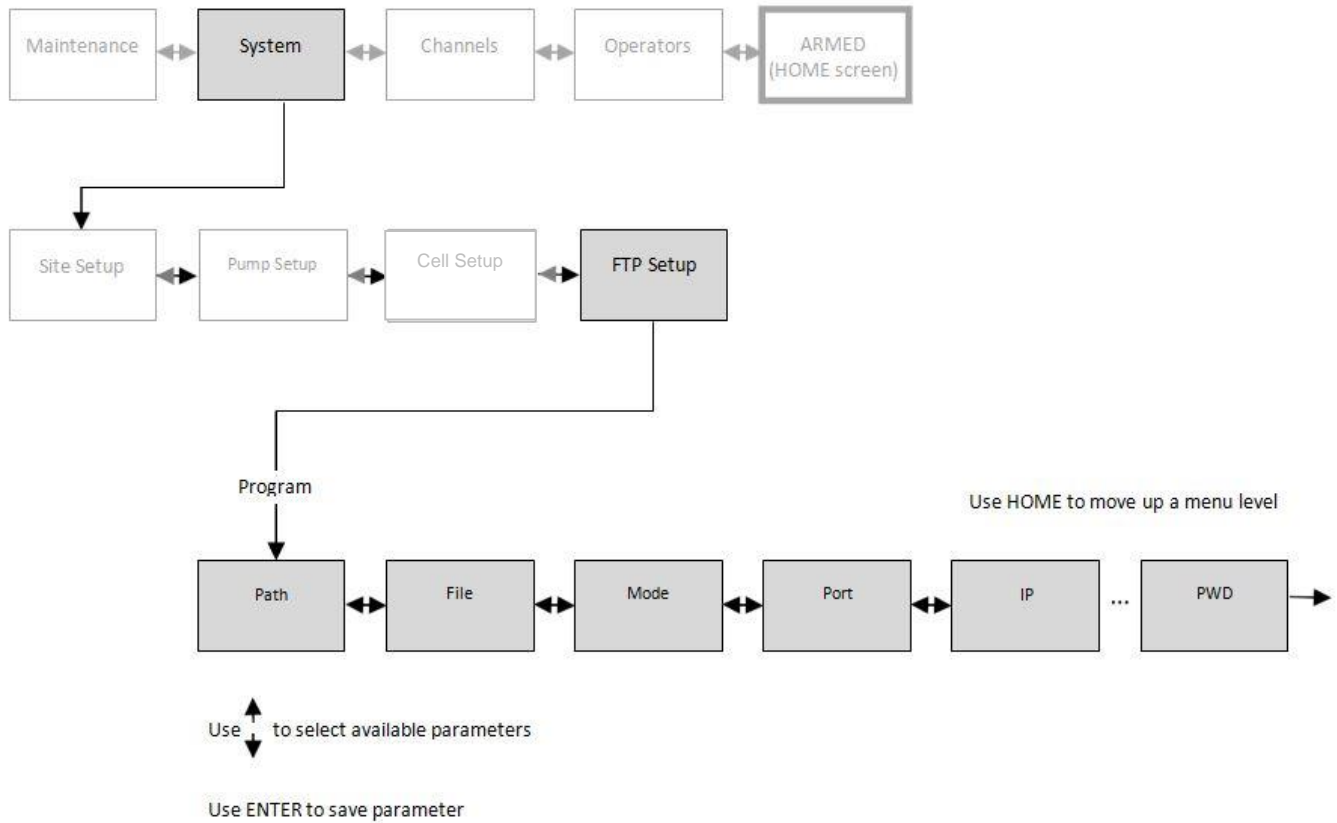

### 14.5.1 FTP Parameters

The FTP Setup configures Aquavx to send and receive files via FTP.

The FTP Setup section allows the user to program the following:

| Parameter   | Description   |
|-------------|---|
| <b>Path</b> | Path to a folder/directory on the FTP server from which to get files or send files. For example, ./ specifies the root directory.   |
| <b>File</b> | Name of the file to get from the FTP server or send to the FTP server.  |
| <b>Mode</b> | <b>Selections:</b> <i>passive</i> , <i>active</i> . Indicates if the FTP server is a passive or active site. Typically if the FTP site is behind a firewall, it is an active site. <i>Protected</i> . |
| <b>Port</b> | FTP port to use. <i>Protected</i> . Typically 21 for FTP sites.   |
| <b>IP</b>   | DNS or IP number. <i>Protected</i> .  |
| <b>USR</b>  | Username of FTP account. <i>Protected</i> .   |
| <b>PWD</b>  | Enter a password if needed. <i>Protected</i> .  |



## 14.6 Serial Ports 1 and 2 Setup

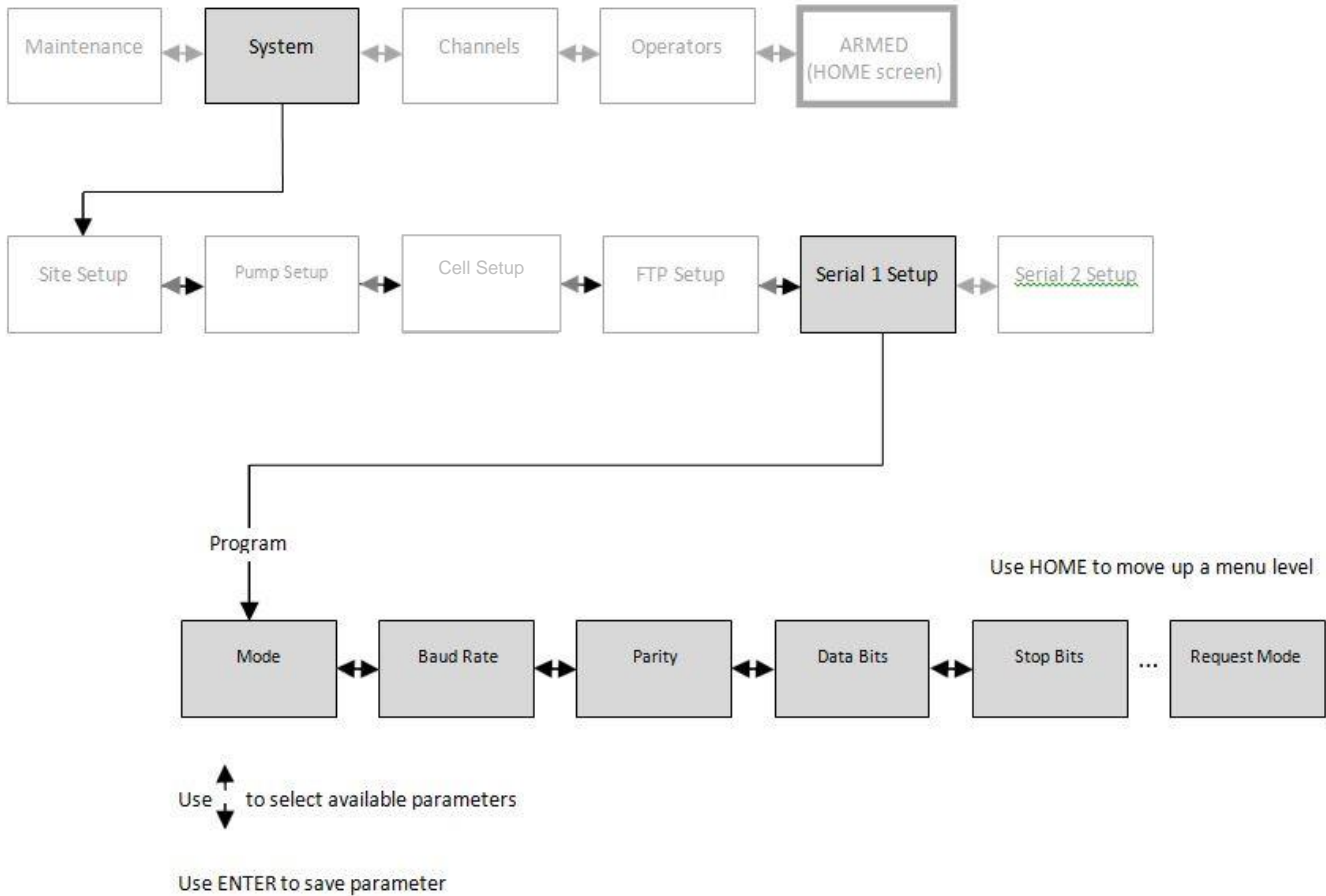

### 14.6.1 Serial Port Parameters

The Serial Port Setup configures the two serial ports of Aquavx for use as Modbus, Cell or Debug.

The Serial Port Setup section allows the user to program the following:

| Parameter        | Description  |
|------------------|--|
| <b>Mode</b>      | <b>Selections:</b> <i>None, Cell, Debug, Master.</i><br>Serial Port 1 (DB9) is configured as Cell as shipped from the factory. <i>Protected.</i><br>Serial Port 2 (header on printed circuit board) is configured as None as shipped from the factory. <i>Protected.</i> |
| <b>Baud Rate</b> | <b>Selections:</b> <i>1200 – 115200. Protected.</i>  |
| <b>Parity</b>    | <b>Selections:</b> <i>None, Even, Odd. Protected.</i>  |
| <b>Data Bits</b> | <b>Selections:</b> <i>7 or 8. Protected.</i>   |
| <b>Stop Bits</b> | <b>Selections:</b> <i>1 or 2. Protected.</i>   |



| Parameter               | Description  |
|-------------------------|--|
| <b>Max Idle</b>         | Amount of time Aquavx waits for the next character to be received after receiving a character. Typically used for Modbus applications. Allowable range: 5-4000 msec.   |
| <b>Response Timeout</b> | Maximum amount of time Aquavx waits for a response after issuing a command. Allowable range: 100-10000 msec.   |
| <b>Scan Rate</b>        | Frequency at which Aquavx requests data via Modbus. Allowable range: 1-60 seconds.   |
| <b>Request Mode</b>     | <b>Selections:</b> <i>single, block</i> . Specifies if Aquavx should request each Modbus register one at a time (single) or request a block or series of registers in each message from the Modbus slave devices back to Aquavx (block). |



## 14.7 Channel Setup

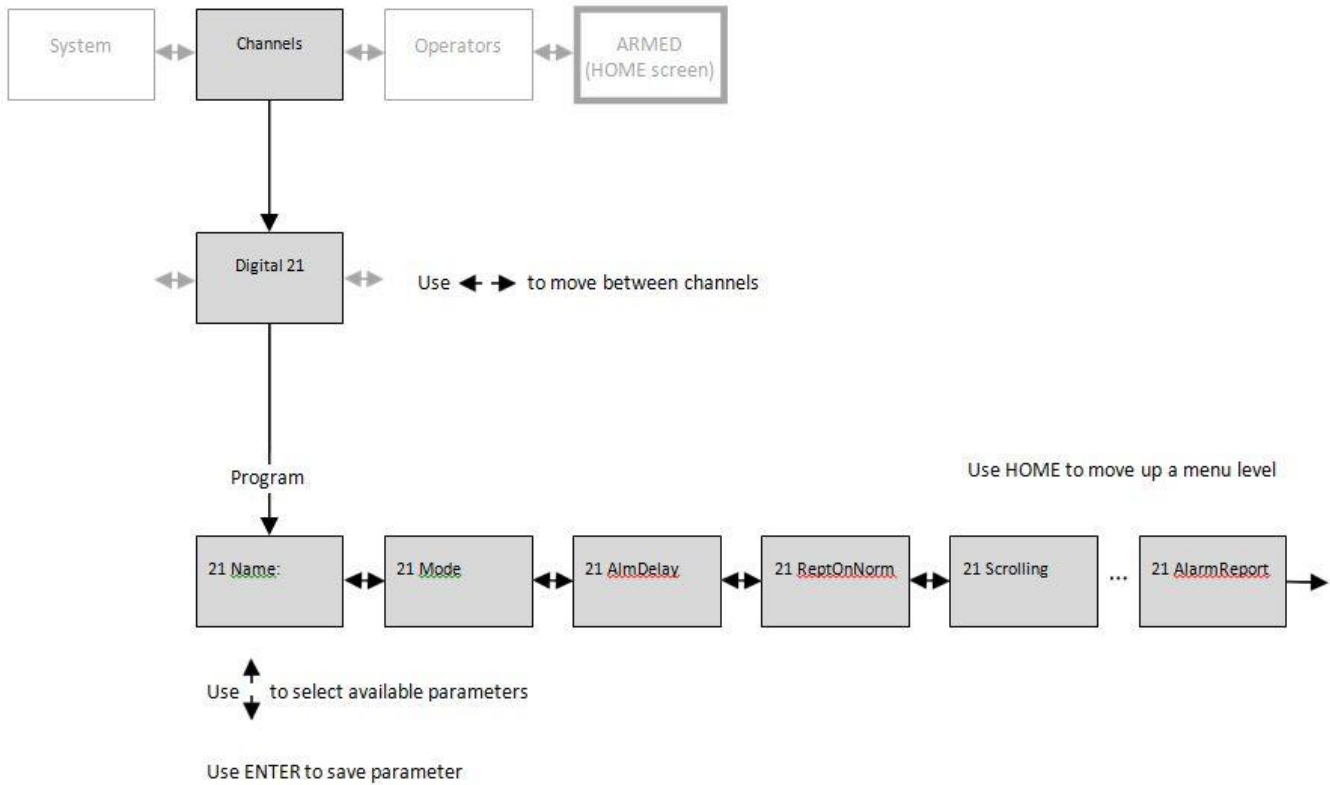

### 14.7.1 System Channel Parameters

The Channel Setup section allows the user to configure the following types of channels:

- Digital (physical)
- Analog (physical)
- Modbus digital input
- Modbus analog
- Modbus coil output
- Derived
- System

The Channel Setup section allows the user to program the following:

| System – Channels 1-5 |  |
|-----------------------|--|
| <b>Name</b>           | Label to identify this channel:<br>1-Power, 2-Low battery, 3-Low Low battery, 4-Cell, 5-Comm.                        |
| <b>Mode</b>           | <b>Selections:</b> <i>disabled, status only, call on violation. Protected.</i>                                       |
| <b>Alarm Delay</b>    | Amount of time input must be in the non-Normal state before it goes into alarm.<br>Allowable range: 0-65535 seconds. |



**System – Channels 1-5**

|                                   |  |
|-----------------------------------|--|
| <b>Report on Return to Normal</b> | <b>Selections:</b> <i>disabled, enabled.</i> Send report to the internet hosted-services when the input returns to Normal state. |
| <b>Scrolling</b>                  | <b>Selections:</b> <i>not included, included.</i> Include channel in the automatic Scrolling display.                            |
| <b>Alarm Relay Channel</b>        | <b>Selections:</b> <i>Channel 151-158.</i> Relay to activate when channel goes into alarm.                                       |
| <b>Periodic Reports</b>           | <b>Selections:</b><br><i>not included in report</i>  |
| <b>End-of-Day Reports</b>         | <i>current value included in report</i>  |
| <b>Alarm Reports</b>              | <i>current value + totals (counts and duration)</i><br><i>current value + totals + max/min</i>                                   |



## 14.7.2 Digital Input Parameters

| Digital Input (Physical) – Channels 21-30 |   |
|---|---|
| <b>Name</b>                               | Label to identify this channel.   |
| <b>Mode</b>                               | <b>Selections:</b> <i>disabled, status only, call on violation. Protected.</i>  |
| <b>Normal State</b>                       | <b>Selections:</b> <i>normally open, normally closed.</i><br><br><b>Note:</b> An alarm occurs when the input transitions out of the 'normal' state. |
| <b>Alarm Delay</b>                        | Amount of time input must be in the non-Normal state before it goes into alarm. Allowable range: 0-65535 seconds.                                   |
| <b>Report on Return to Normal</b>         | <b>Selections:</b> <i>disabled, enabled.</i> Send report to the internet hosted-services when the input returns to Normal state.                    |
| <b>Scrolling</b>                          | <b>Selections:</b> <i>not included, included.</i> Include channel in the automatic Scrolling display.   |
| <b>Counts Limit</b>                       | An alarm limit on the number of times that the channel has transitioned to the non-Normal condition.  |
| <b>Duration Limit</b>                     | An alarm limit on the total time that the channel is in the non-Normal condition. Specified in seconds.   |
| <b>Alarm Relay Channel</b>                | <b>Selections:</b> <i>Channel 151-158.</i> Relay to activate when channel goes into alarm.  |
| <b>Periodic Reports</b>                   | <b>Selections:</b> <i>not included in report</i>  |
| <b>End-of-Day Reports</b>                 | <i>current value included in report</i>   |
| <b>Alarm Reports</b>                      | <i>current value + totals (counts and duration)</i><br><i>current value + totals + max/min</i>  |



### 14.7.3 Relay Output Parameters

| Relay Output – Channels 71-72 |   |
|-------------------------------|---|
| <b>Name</b>                   | Label to identify this channel.   |
| <b>Mode</b>                   | <b>Selections:</b> (0) - disabled, (1) - status only (enabled), (2) - call on state change. Protected.            |
| <b>Pulse Duration</b>         | Number of seconds to keep the relay activated. Allowable range: 0 – 65535; 0 means not automatically deactivated. |
| <b>Scrolling</b>              | <b>Selections:</b> not included, included. Include channel in the automatic Scrolling display.                    |
| <b>Periodic Reports</b>       | <b>Selections:</b> not included in report   |
| <b>End-of-Day Reports</b>     | current value included in report  |
| <b>Alarm Reports</b>          | current value + totals (counts and duration)<br>current value + totals + max/min                                  |

If the Mode is set to “Call On State Change”, then whenever the state of the relay changes, a report is sent to RMS. The state of the output can change from:

- Control from RMS
- Control from a monitored channel going into alarm
- Manual control from the Aquavx front panel
- Pulse duration expiring causing the output to go off after being turned on





## 14.7.4 Analog Input Parameters

| Analog Input (Physical) – Channels 51-54 |   |              |                   |
|--|---|--------------|-------------------|
| <b>Name</b>                              | Label to identify this channel.   |              |                   |
| <b>Mode</b>                              | <b>Selections:</b> <i>disabled, status only, call on violation. Protected.</i>  |              |                   |
| <b>Alarm Delay</b>                       | Amount of time input must be in the non-Normal state before it goes into alarm. Allowable range: 0-65535 seconds.   |              |                   |
| <b>Report on Return to Normal</b>        | <b>Selections:</b> <i>disabled, enabled.</i> Send report to the internet hosted-services when the input returns to Normal state.  |              |                   |
| <b>Scrolling</b>                         | <b>Selections:</b> <i>not included, included.</i> Include channel in the automatic Scrolling display.   |              |                   |
| <b>Display Precision</b>                 | Number of digits to the right of the decimal. Allowable digits: 0-6.  |              |                   |
| <b>Engineering Units</b>                 | <b>Selections:</b>  |              |                   |
|  | 0 none  | 7 rpm        | 13 km (kilometer) |
|  | 1 % (percentage)  | 8 psi        | 14 L (liter)      |
|  | 2 ppm   | 9 °C         | 15 kL (kiloliter) |
|  | 3 gal   | 10 °F        | 16 gm (gram)      |
|  | 4 gpm   | 11 in (inch) | 17 kg (kilogram)  |
|  | 5 gph   | 12 m (meter) | 18 lb (pound)     |
| 6 ft (feet)                              |   |              |                   |
| <b>Input Type</b>                        | <b>Selections:</b> <i>0-5 V, 1-5 V, 0-20 mA, 4-20 mA.</i>   |              |                   |
| <b>Zero Scale</b>                        | The engineering unit value at the lowest input level.<br>For example, for a 4-20 mA signal, this is the engineering unit value at 4 mA with the specified decimal point position. |              |                   |
| <b>Full Scale</b>                        | The engineering unit value at the highest input level.  |              |                   |
| <b>Low Limit</b>                         | If the current reading is below the Low Limit for the Alarm Delay period, the channel initiates an alarm report and/or relay activation.  |              |                   |
| <b>High Limit</b>                        | If the current reading is above the High Limit for the Alarm Delay period, the channel initiates an alarm report and/or relay activation.   |              |                   |
| <b>Low Fail Safe</b>                     | If the current reading is below Low Fail Safe, the channel is NOT in alarm.   |              |                   |
| <b>High Fail Safe</b>                    | If the current reading is above the High Fail Safe, the channel is NOT in alarm.  |              |                   |
| <b>Low Alarm Relay</b>                   | <b>Selections:</b> <i>Channel 151-158.</i> Relay to activate when Low Limit is violated.  |              |                   |
| <b>High Alarm Relay</b>                  | <b>Selections:</b> <i>Channel 151-158.</i> Relay to activate when High Limit is violated.   |              |                   |
| <b>Periodic Reports</b>                  | <b>Selections:</b><br><i>not included in report</i>   |              |                   |
| <b>End-of-Day Reports</b>                | <i>current value included in report</i>   |              |                   |
| <b>Alarm Reports</b>                     | <i>current value + totals (counts and duration)</i><br><i>current value + totals + max/min</i>  |              |                   |



## 14.7.5 Modbus Digital Input Parameters

| Modbus Digital Input – Channels 91-110 |  |
|--|--|
| <b>Name</b>                            | Label to identify this channel.  |
| <b>Slave ID</b>                        | ID of slave device for this channel. Allowable range: 0-247.   |
| <b>Register Type</b>                   | <b>Selections:</b> <i>RdCoil</i> or <i>RdStatus</i> .  |
| <b>Register Number</b>                 | 0-xxxxxx.  |
| <b>Mode</b>                            | <b>Selections:</b> <i>disabled</i> , <i>status only</i> , <i>call on violation</i> . <i>Protected</i> .  |
| <b>Normal State</b>                    | <b>Selections:</b> <i>normally open</i> , <i>normally closed</i> .<br><br><b>Note:</b> An alarm occurs when the input transitions out of the 'normal' state. |
| <b>Alarm Delay</b>                     | Amount of time input must be in the non-Normal state before it goes into alarm. Allowable range: 0-65535 seconds.  |
| <b>Report on Return to Normal</b>      | <b>Selections:</b> <i>disabled</i> , <i>enabled</i> . Send report to the internet hosted-services when the input returns to Normal state.                    |
| <b>Scrolling</b>                       | <b>Selections:</b> <i>not included</i> , <i>included</i> . Include channel in the automatic Scrolling display.   |
| <b>Alarm Relay Channel</b>             | <b>Selections:</b> <i>Channel 151-158</i> . Relay to activate when channel goes into alarm.  |
| <b>Periodic Reports</b>                | <b>Selections:</b>   |
| <b>End-of-Day Reports</b>              | <i>not included in report</i>  |
| <b>Alarm Reports</b>                   | <i>current value included in report</i>  |
|  | <i>current value + totals (counts and duration)</i>  |
|  | <i>current value + totals + max/min</i>  |



## 14.7.6 Modbus Analog Input Parameters

| Modbus Analog Input – Channels 121-150 |   |                   |       |                   |                  |       |              |       |      |                   |       |       |              |       |              |                  |       |              |               |             |  |  |
|--|---|-------------------|-------|-------------------|------------------|-------|--------------|-------|------|-------------------|-------|-------|--------------|-------|--------------|------------------|-------|--------------|---------------|-------------|--|--|
| <b>Name</b>                            | Label to identify this channel.   |                   |       |                   |                  |       |              |       |      |                   |       |       |              |       |              |                  |       |              |               |             |  |  |
| <b>Slave ID</b>                        | ID of slave device for this channel. Allowable range: 0-247.  |                   |       |                   |                  |       |              |       |      |                   |       |       |              |       |              |                  |       |              |               |             |  |  |
| <b>Register Type</b>                   | <b>Selections:</b> <i>RdHolding</i> or <i>RdInput</i> .   |                   |       |                   |                  |       |              |       |      |                   |       |       |              |       |              |                  |       |              |               |             |  |  |
| <b>Register Number</b>                 | 0-xxxxxx.   |                   |       |                   |                  |       |              |       |      |                   |       |       |              |       |              |                  |       |              |               |             |  |  |
| <b>Mode</b>                            | <b>Selections:</b> <i>disabled</i> , <i>status only</i> , <i>call on violation</i> . <i>Protected</i> .   |                   |       |                   |                  |       |              |       |      |                   |       |       |              |       |              |                  |       |              |               |             |  |  |
| <b>Alarm Delay</b>                     | Amount of time input must be in the non-Normal state before it goes into alarm. Allowable range: 0-65535 seconds.   |                   |       |                   |                  |       |              |       |      |                   |       |       |              |       |              |                  |       |              |               |             |  |  |
| <b>Report on Return to Normal</b>      | <b>Selections:</b> <i>disabled</i> , <i>enabled</i> . Send report to the internet hosted-services when the input returns to Normal state.   |                   |       |                   |                  |       |              |       |      |                   |       |       |              |       |              |                  |       |              |               |             |  |  |
| <b>Scrolling</b>                       | <b>Selections:</b> <i>not included</i> , <i>included</i> . Include channel in the automatic Scrolling display.  |                   |       |                   |                  |       |              |       |      |                   |       |       |              |       |              |                  |       |              |               |             |  |  |
| <b>Display Precision</b>               | Number of digits to the right of the decimal. Allowable digits: 0-6.  |                   |       |                   |                  |       |              |       |      |                   |       |       |              |       |              |                  |       |              |               |             |  |  |
| <b>Engineering Units</b>               | <p><b>Selections:</b></p> <table border="0"> <tr> <td>0 none</td> <td>7 rpm</td> <td>13 km (kilometer)</td> </tr> <tr> <td>1 % (percentage)</td> <td>8 psi</td> <td>14 L (liter)</td> </tr> <tr> <td>2 ppm</td> <td>9 °C</td> <td>15 kL (kiloliter)</td> </tr> <tr> <td>3 gal</td> <td>10 °F</td> <td>16 gm (gram)</td> </tr> <tr> <td>4 gpm</td> <td>11 in (inch)</td> <td>17 kg (kilogram)</td> </tr> <tr> <td>5 gph</td> <td>12 m (meter)</td> <td>18 lb (pound)</td> </tr> <tr> <td>6 ft (feet)</td> <td></td> <td></td> </tr> </table> | 0 none            | 7 rpm | 13 km (kilometer) | 1 % (percentage) | 8 psi | 14 L (liter) | 2 ppm | 9 °C | 15 kL (kiloliter) | 3 gal | 10 °F | 16 gm (gram) | 4 gpm | 11 in (inch) | 17 kg (kilogram) | 5 gph | 12 m (meter) | 18 lb (pound) | 6 ft (feet) |  |  |
| 0 none                                 | 7 rpm   | 13 km (kilometer) |       |                   |                  |       |              |       |      |                   |       |       |              |       |              |                  |       |              |               |             |  |  |
| 1 % (percentage)                       | 8 psi   | 14 L (liter)      |       |                   |                  |       |              |       |      |                   |       |       |              |       |              |                  |       |              |               |             |  |  |
| 2 ppm                                  | 9 °C  | 15 kL (kiloliter) |       |                   |                  |       |              |       |      |                   |       |       |              |       |              |                  |       |              |               |             |  |  |
| 3 gal                                  | 10 °F   | 16 gm (gram)      |       |                   |                  |       |              |       |      |                   |       |       |              |       |              |                  |       |              |               |             |  |  |
| 4 gpm                                  | 11 in (inch)  | 17 kg (kilogram)  |       |                   |                  |       |              |       |      |                   |       |       |              |       |              |                  |       |              |               |             |  |  |
| 5 gph                                  | 12 m (meter)  | 18 lb (pound)     |       |                   |                  |       |              |       |      |                   |       |       |              |       |              |                  |       |              |               |             |  |  |
| 6 ft (feet)                            |   |                   |       |                   |                  |       |              |       |      |                   |       |       |              |       |              |                  |       |              |               |             |  |  |
| <b>Register Signed</b>                 | <b>Selections:</b> <i>16-bit signed</i> , <i>16-bit unsigned</i> . Defines how the value read by Aquavx is interpreted.   |                   |       |                   |                  |       |              |       |      |                   |       |       |              |       |              |                  |       |              |               |             |  |  |
| <b>Register Scaled/Unscaled</b>        | <b>Unscaled</b> - the value being read is in the desired units. <b>Scaled</b> - the value read from the remote device is returned in counts. To convert the counts to engineering units, configure the Zero and Full Scale parameters.  |                   |       |                   |                  |       |              |       |      |                   |       |       |              |       |              |                  |       |              |               |             |  |  |
| <b>Zero Scale</b>                      | The engineering unit value at the lowest input level.<br>For example, for a 4-20 mA signal, this is the engineering unit value at 4 mA with the specified decimal point position.   |                   |       |                   |                  |       |              |       |      |                   |       |       |              |       |              |                  |       |              |               |             |  |  |
| <b>Full Scale</b>                      | The engineering unit value at the highest input level.  |                   |       |                   |                  |       |              |       |      |                   |       |       |              |       |              |                  |       |              |               |             |  |  |
| <b>Low Limit</b>                       | If the current reading is below the Low Limit for the Alarm Delay period, the channel initiates an alarm report and/or relay activation.  |                   |       |                   |                  |       |              |       |      |                   |       |       |              |       |              |                  |       |              |               |             |  |  |
| <b>High Limit</b>                      | If the current reading is above the High Limit for the Alarm Delay period, the channel initiates an alarm report and/or relay activation.   |                   |       |                   |                  |       |              |       |      |                   |       |       |              |       |              |                  |       |              |               |             |  |  |
| <b>Low Alarm Relay</b>                 | <b>Selections:</b> <i>Channel 151-158</i> . Relay to activate when Low Limit is violated.   |                   |       |                   |                  |       |              |       |      |                   |       |       |              |       |              |                  |       |              |               |             |  |  |
| <b>High Alarm Relay</b>                | <b>Selections:</b> <i>Channel 151-158</i> . Relay to activate when High Limit is violated.  |                   |       |                   |                  |       |              |       |      |                   |       |       |              |       |              |                  |       |              |               |             |  |  |
| <b>Periodic Reports</b>                | <b>Selections:</b><br><i>not included in report</i>   |                   |       |                   |                  |       |              |       |      |                   |       |       |              |       |              |                  |       |              |               |             |  |  |
| <b>End-of-Day Reports</b>              | <i>current value included in report</i>   |                   |       |                   |                  |       |              |       |      |                   |       |       |              |       |              |                  |       |              |               |             |  |  |
| <b>Alarm Reports</b>                   | <i>current value + totals (counts and duration)</i><br><i>current value + totals + max/min</i>  |                   |       |                   |                  |       |              |       |      |                   |       |       |              |       |              |                  |       |              |               |             |  |  |



## 14.7.7 Modbus Digital Output Parameters

| Modbus Digital Output – Channels 151-158 |  |
|--|--|
| <b>Name</b>                              | Label to identify this channel.  |
| <b>Slave ID</b>                          | ID of slave device for this channel. Allowable range: 0-247.   |
| <b>Register Type</b>                     | <i>WrCoil.</i>   |
| <b>Register Number</b>                   | 0-xxxxxx.  |
| <b>Mode</b>                              | <b>Selections:</b> (0) - disabled, (1) - status only (enabled), (2) - call on state change.<br><i>Protected.</i>     |
| <b>Pulse Duration</b>                    | Number of seconds to keep the relay activated. Allowable range: 0 – 65535;<br>0 means not automatically deactivated. |
| <b>Scrolling</b>                         | <b>Selections:</b> <i>not included, included.</i> Include channel in the automatic Scrolling display.                |
| <b>Periodic Reports</b>                  | <b>Selections:</b><br><i>not included in report</i>  |
| <b>End-of-Day Reports</b>                | <i>current value included in report</i>  |
| <b>Alarm Reports</b>                     | <i>current value + totals (counts and duration)</i><br><i>current value + totals + max/min</i>                       |

If the Mode is set to Call On State Change, then whenever the state of the relay changes a report is sent to RMS. The state of the output can change from:

- Control from RMS
- Control from a monitored channel going into alarm
- Manual control from the Aquavx front panel
- Pulse duration expiring causing the output to go off after being turned on



## 14.7.8 Derived Analog Parameters

| Derived Analog – Channels 171-174 |   |              |                   |
|-----------------------------------|---|--------------|-------------------|
| <b>Name</b>                       | Label to identify this channel.   |              |                   |
| <b>Mode</b>                       | <b>Selections:</b> <i>disabled, status only, call on violation. Protected.</i>  |              |                   |
| <b>Alarm Delay</b>                | Amount of time input must be in the non-Normal state before it goes into alarm. Allowable range: 0-65535 seconds.                         |              |                   |
| <b>Report on Return to Normal</b> | <b>Selections:</b> <i>disabled, enabled.</i> Send report to the internet hosted-services when the input returns to Normal state.          |              |                   |
| <b>Scrolling</b>                  | <b>Selections:</b> <i>not included, included.</i> Include channel in the automatic Scrolling display.                                     |              |                   |
| <b>Display Precision</b>          | Number of digits to the right of the decimal. Allowable digits: 0-6.  |              |                   |
| <b>Engineering Units</b>          | <b>Selections:</b>  |              |                   |
|                                   | 0 none  | 7 rpm        | 13 km (kilometer) |
|                                   | 1 % (percentage)  | 8 psi        | 14 L (liter)      |
|                                   | 2 ppm   | 9 °C         | 15 kL (kiloliter) |
|                                   | 3 gal   | 10 °F        | 16 gm (gram)      |
|                                   | 4 gpm   | 11 in (inch) | 17 kg (kilogram)  |
|                                   | 5 gph   | 12 m (meter) | 18 lb (pound)     |
| 6 ft (feet)                       |   |              |                   |
| <b>Low Limit</b>                  | If the current reading is below the Low Limit for the Alarm Delay period, the channel initiates an alarm report and/or relay activation.  |              |                   |
| <b>High Limit</b>                 | If the current reading is above the High Limit for the Alarm Delay period, the channel initiates an alarm report and/or relay activation. |              |                   |
| <b>Low Alarm Relay</b>            | <b>Selections:</b> <i>Channel 151-158.</i> Relay to activate when Low Limit is violated.  |              |                   |
| <b>High Alarm Relay</b>           | <b>Selections:</b> <i>Channel 151-158.</i> Relay to activate when High Limit is violated.   |              |                   |
| <b>Periodic Reports</b>           | <b>Selections:</b> <i>not included in report</i>  |              |                   |
| <b>End-of-Day Reports</b>         | <i>current value included in report</i>   |              |                   |
| <b>Alarm Reports</b>              | <i>current value + totals (counts and duration)</i><br><i>current value + totals + max/min</i>  |              |                   |



## 15 Receiving SMS Commands

### 15.1 Overview

Aquavx can receive and act on SMS commands to perform several functions. SMS commands are rarely used as the internet hosted-services system allows for all of these operations; however, if the user does not have access to the internet, issuing these commands via a cell phone can prove to be very useful.

### 15.2 SMS Commands

| SMS Command Format    | Parameter Description                                      | Function   |
|-----------------------|--|--|
| <RELY (cnum, state) > | cnum = channel #<br>state = 0 (deactivate) or 1 (activate) | Activates or deactivates the specified relay (Modbus Digital Output, channel 151-158). |
| <ACTN (2) >           | action number  | Send status report via SMS to mobile device that sent this ACTN command.               |

### 15.3 Making Configuration Changes

Configuration changes are performed by entering a Configuration Line either through the serial Debug port or through an always-on over-the-air (OTA) connection.

Any configuration changes made are stored in non-volatile memory.

The format for the Configuration Line is the same regardless of the method being used, as shown below:

**The Configuration Line format via the serial port Debug Menu is:**

```
x, <i, >y, zzzz, y, zzzz, y, zzzz<CR><LF>
```

Example, setting analog channel 51, low limit=4.0 high limit=21.2:  
9, 51, 15, 4.0, 16, 21.2<CR><LF>

**The Configuration Line format via OTA is:**

```
&&|258, x, <i, >y, zzzz, y, zzzz, y, zzzz | <CR><LF>
```

Example, setting analog channel 51, low limit=4.0 high limit=21.2:  
&&|258, 9, 51, 15, 4.0, 16, 21.2|<cr><lf>

Where:

|          |  |
|----------|--|
| x        | Line type code   |
| <i, >    | Optional index value (function of the line type code)<br>For example: Channel number, Port number, Geofence number |
| y        | Field type code  |
| zzzz     | Field value  |
| <CR><LF> | Line terminator (use one or both)  |



| Line Type Codes |          |   |
|-----------------|----------|---|
| 1               | Site     | System wide settings.   |
| 2               | Options  | Optional settings.  |
| 3               | Cell     | Cell communication settings.                                    |
| 4               | FTP      | FTP settings.   |
| 9               | Channels | Physical digital and analog and Modbus channel settings.        |
| 12              | Reports  | Updates to the web server.                                      |
| 20              | Pump     | Settings to perform volumetric inflow and outflow calculations. |
| 21              | Operator | List of operators that can be on-site.                          |

| Field Type Codes for Site (1) |                                 |  |
|-------------------------------|---------------------------------|--|
| 1                             | ID (name)                       | 30 character unique site name  |
| 2                             | Access code (acc)               | 4 character value, -001 means none assigned  |
| 3                             | Keypad sensitivity (ksens)      | 1-5  |
| 4                             | Daylight Saving enabled (dst)   | 0 – not enabled, 1 – enabled   |
| 5                             | Timezone (tzone)                | 0 – GMT, 1 – Atlantic, 2 – Eastern, 3 – Central, 4 – Mountain, 5 – Pacific, 6 – Alaska, 7 – Hawaii   |
| 6                             | Call Delay (calldly)            | 0-32000 seconds  |
| 7                             | Report Rate (reprate)           | 1-1440 minutes   |
| 8                             | Delimiter (delim)               | 0-255, decimal value to specify an ASCII character to be used as the delimiter by the Aquavx Protocol. Defaults to 58.                                     |
| 9                             | Start Message Character (start) | 0 – no start character used.<br>1-255 – insert two of this same character at the beginning of every report when using the Aquavx Protocol. Defaults to 38. |

Example:

Via debug menu:  
1, 7, 120<CR><LF>

Via OTA:  
&&|258, 7, 120|

Report every 120 minutes.



### Field Type Codes for Options (2)

|   |   |                         |
|---|---|-------------------------|
| 3 | Dampen analog input values (damp)   | 1 – enable, 0 – disable |
| 4 | Allow automatic scrolling of the status of user-selected channels (scroll)        | 1 – enable, 0 – disable |
| 8 | Add Msg Checksum (checksum)   | 1 – enable, 0 – disable |
| 9 | Automatically send the configuration to the backend whenever it changes (sendcfg) | 1 – enable, 0 – disable |

#### Example:

Via debug menu:

```
2,8,0<CR><LF>
```

Via OTA:

```
&&|258,2,8,0|
```

Options, checksum, 0 = checksum option set to disabled.

---





### Field Type Codes for Cell (3)

|    |   |  |
|----|---|--|
| 1  | Wait on ACK from server when sending any Report (ack) | 1 – ack required for each Report sent. If not received, record is stored in store and forward buffer.<br>0 – no ack is expected. |
| 2  | Auto set of time from Time Servers (settime)          | 1 – set real-time clock automatically on power-up and at midnight.<br>0 – do not set time.                                       |
| 3  | PING rate (ping)                                      | In minutes   |
| 4  | UDP or TCP protocol (prot)                            | 1 – TCP, 0 – UDP   |
| 5  | UDP or TCP port number (port)                         | 1-65535  |
| 6  | UDP or TCP (ip)                                       | 127 characters – specify IP or DNS address. For example, www.myip.com.   |
| 7  | Service provider ID (sp)                              | When set, the APN, Username and Password are automatically filled.<br>0 – T-Mobile, 1 – AT&T, 3 – KORE                           |
| 8  | APN (apn)   | 63 characters  |
| 9  | Username (uname)                                      | 63 characters  |
| 10 | Password (pword)                                      | 63 characters  |

Example:

Via Debug Menu:

3,1,1,4,0,5,2291,6,www.ourserver.com<CR><LF>

Cell, Ack enabled, UDP, port 2291, IP is [www.ourserver.com](http://www.ourserver.com).



#### Field Type Codes for FTP (4)

|   |                           |   |
|---|---------------------------|---|
| 1 | Get filename (fname)      | 63 characters. For example, aquavx-hdr.bin                            |
| 2 | Get path on server (path) | 63 characters. For example, ./<br>Would be the top or root directory. |
| 3 | FTP mode (mode)           | 1 – active, 0 – passive   |
| 4 | Server port number (port) | Typically 21  |
| 5 | Server IP (ip)            | 127 characters IP or DNS address. For example, 111.22.333.44          |
| 6 | Login username (uname)    | 63 characters   |
| 7 | Login password (pword)    | 63 characters   |

Example:

Via debug Menu:

```
4,1,new_config.cfg,2,./liftstations/,  
5,111.22.333.44,6,ftpuser,7,secret<CR><LF>
```

Settings to get a new configuration file “new\_config.cfg” from the folder ./liftstations on ftp server 111.22.333.44 using the specified username and password.

---

**Note:** Once the port, IP, username and password have been sent, those parameters do not need to be sent again unless they need to change.

---



**Field Type Codes for Physical Analog Channels (9)**  
(use optional <i>, to specify channel number 51-54)

|    |                                      |   |
|----|--------------------------------------|---|
| 1  | Channel name (name)                  | 30 characters   |
| 7  | Mode (mode)                          | 0 – disabled, 1 – status only, 2 – report on violations                               |
| 8  | Alarm delay (almdly)                 | 0-65535 seconds   |
| 9  | Report on return to normal (repnorm) | 0 – disabled<br>1 – enabled, report when the channel returns to the normal condition. |
| 10 | Report Flags (repflgs)               | Reserved  |
| 11 | Display Precision (prec)             | # of digits to the right of the decimal, Allowable digits: 0-6.                       |
| 12 | Input Type (type)                    | 0 = 0-5 V      1 = 1-5 V      2 = 0-20 mA      3 = 4-20 mA                            |
| 13 | Zero (zscale)                        | +/- 999999.99999  |
| 14 | Full Scale (fscale)                  | +/- 999999.99999  |
| 15 | Low alarm limit (loalm)              | +/- 999999.99999  |
| 16 | High alarm limit (hialm)             | +/- 999999.99999  |
| 17 | Low fail safe (lofs)                 | +/- 999999.99999  |
| 18 | High fail safe (hifs)                | +/- 999999.99999  |
| 19 | Low alarm relay (lorly)              | 151-158, channel of a relay   |
| 20 | High alarm relay (hirly)             | 151-158, channel of a relay   |
| 21 | Engineering Units                    | See the <a href="#">Glossary</a> section.   |

Example:

Via debug menu:

```
9,51,1,Tank Level (feet),5,1,6,15,9,1,12,3,
13,0.0,14,23.1,16,8.5<CR><LF>
```

Via OTA:

```
&&|258,9,51,1,Tank Level (feet),5,1,6,15,9,1,12,3, 13,0.0,14,23.1,16,8.5|
```

Channel 51, name is Tank Level (feet), 4-20 mA input, 0 to 23.1, high level alarm at 8.5.



**Field Type Codes for Physical Digital Channels (9)**  
(use optional <i>, to specify channel number 21-28)

|    |                                      |   |
|----|--------------------------------------|---|
| 1  | Channel name (name)                  | 30 characters   |
| 5  | Mode (mode)                          | 0 – disabled, 1 – status only, 2 – report on violations                               |
| 6  | Alarm delay (almdly)                 | 0-65535 seconds   |
| 7  | Report on return to normal (repnorm) | 0 – disabled<br>1 – enabled, report when the channel returns to the normal condition. |
| 8  | Report Flags (repflgs)               | Reserved  |
| 9  | Normal state (norm)                  | 0 – normally open, 1 – normally closed  |
| 10 | Starts limit (strtlm)                | 0-999999  |
| 11 | Run Limit (durlim)                   | 0-999999  |
| 12 | Alarm Relay (almrly)                 | Channel number of relay to control when in alarm (0,151-158)                          |

Example:

Via debug menu:

```
9,24,1,Pump 2 Fail,9,1,5,2,6,15<CR><LF>
```

Channels 24, name is Pump 2 Fail, normally closed, report alarms, alarm delay is 15 seconds.



**Field Type Codes for Modbus Channels (9)  
Read Coil and Read Input Status only  
(use optional <i>, to specify channel number 91-106)**

|    |                                      |   |
|----|--------------------------------------|---|
| 1  | Channel name (name)                  | 30 characters   |
| 2  | Slave ID (slave)                     | 0-247, 0 if disabled<br>1-247 for Modbus Slave ID                                     |
| 3  | Function code (fcode)                | 0-5<br>0 – Null, 1 – Read Coil, 2 – Read Status                                       |
| 4  | Register number (regnum)             | 0-9999  |
| 5  | Mode (mode)                          | 0 – disabled, 1 – status only, 2 – report on violations                               |
| 6  | Alarm delay (almdly)                 | 0-65535 seconds   |
| 7  | Report on return to normal (repnorm) | 0 – disabled<br>1 – enabled, report when the channel returns to the normal condition. |
| 9  | Normal state (norm)                  | 0 – normally open, 1 – normally closed  |
| 12 | Alarm Relay (almrly)                 | Channel number of relay to control when in alarm (0,151-158)                          |

Example:

Via debug menu:

9, 91, 2, 101, 3, 1, 4, 21, 5, 2, 6, 15, 9, 0

Modbus channel 91, read coil, register number 21, mode is report violations, Alarm delay is 15 seconds and the channel state is normally open.



**Field Type Codes for Modbus Channels (9)**  
**Read Holding and Read Input only**  
 (use optional <i>, to specify channel number 121-136)

|    |                                       |   |
|----|---------------------------------------|---|
| 1  | Channel name (name)                   | 30 characters   |
| 2  | Slave ID (slave)                      | 0-247 0 - disabled  |
| 3  | Function code (fcode)                 | 0 – Null, 3 – Read Holding, 4 – Read Input  |
| 4  | Register number (regnum)              | 0-9999  |
| 5  | Modbus value signed/unsigned (signed) | 0 – unsigned, 1 – signed  |
| 6  | Modbus register scaled (scaled)       | 0 – unscaled, 1 – scaled (if scaled, scales the 0-65535 value to the zero and full scale specified) |
| 7  | Mode (mode)                           | 0 – disabled, 1 – status only, 2 – report on violations   |
| 8  | Alarm delay (almdly)                  | 0-65535 seconds   |
| 9  | Report on return to normal (repnorm)  | 0 – disabled<br>1 – enabled, report when the channel returns to the normal condition.               |
| 11 | Display Precision (prec)              | 0-6, # of digits to the right of the decimal  |
| 13 | Zero scale                            | +/- 999999.99999<br>Zero value that corresponds to the minimum value in counts.                     |
| 14 | Full scale                            | +/- 999999.99999<br>Full scale value that corresponds to the maximum value in counts.               |
| 15 | Low alarm limit (loalm)               | +/- 999999.99999  |
| 16 | High alarm limit (hialm)              | +/- 999999.99999  |
| 19 | Low alarm relay (lorly)               | 151-158, channel of a relay   |
| 20 | High alarm relay (hirly)              | 151-158, channel of a relay   |
| 21 | Engineering Units                     | See the <a href="#">Glossary</a> section.   |

Example:

Via debug menu:

```
9,121,1,Pump 1 Amps,2,15,3,1,4,23,5,2,6,30,
16,12.3,20,151<CR><LF>
```

Modbus channel 121, Slave ID = 15, Holding Register #23, Mode is report violations, Alarm Delay is 30 seconds, High alarm limit is 12.3 amps, relay to trigger on high alarm is 151.



**Field Type Codes for Modbus Channels (9)**  
**Force Coil only**  
**(use optional <i>, to specify channel number 151-158)**

|    |                           |                               |
|----|---------------------------|-------------------------------|
| 1  | Channel name (name)       | 30 characters                 |
| 2  | Slave ID (slave)          | 0-247 0 - disabled            |
| 3  | Function code (fcode)     | 0 – Null, 5 – Write Coil      |
| 4  | Register number (regnum)  | 0-9999                        |
| 5  | Mode (mode)               | 0 – disabled, 1 – status only |
| 13 | Pulse Duration (pulsedur) | 0 – 86400 seconds             |

Example:

Via debug menu:

```
9,151,1,Alarm Relay,2,123,3,5,4,11,5,1,13,0
```

Modbus channel 151, Write Coil, Slave ID = 123, Register number 11, Mode is status only, Pulse duration is 0 (relay stays on until explicitly told to go off).



**Field Type Codes for Derived (Computed) Analog Channels (9)**  
(use optional <i>, to specify channel number 171-174)

|    |                                      |   |
|----|--------------------------------------|---|
| 1  | Channel name (name)                  | 30 characters   |
| 7  | Mode (mode)                          | 0 – disabled, 1 – status only, 2 – report on violations                               |
| 8  | Alarm delay (almdly)                 | 0-65535 seconds   |
| 9  | Report on return to normal (repnorm) | 0 – disabled<br>1 – enabled, report when the channel returns to the normal condition. |
| 10 | Report Flags (repflgs)               | Reserved  |
| 11 | Display Precision (prec)             | # of digits to the right of the decimal. Allowable digits: 0-6.                       |
| 15 | Low alarm limit (loalm)              | +/- 999999.99999  |
| 16 | High alarm limit (hialm)             | +/- 999999.99999  |
| 19 | Low alarm relay (lorly)              | 151-158, channel of a relay   |
| 20 | High alarm relay (hirly)             | 151-158, channel of a relay   |
| 21 | Engineering Units                    | See the <a href="#">Glossary</a> section.   |

Example:

Via debug menu:

```
9,171,1,Inflow,7,2,14,40.0<CR><LF>
```

Via OTA:

```
&&|258,9,171,1,Inflow,7,2,14,40.0|
```

Channel 171, name is Inflow, high alarm is 40.0 cubic feet per second.





**Field Type Codes for Computed Digital Channels (9)**  
(use optional <i>, to specify channel number 201-204)

|    |                                      |   |
|----|--------------------------------------|---|
| 1  | Channel name (name)                  | 30 characters   |
| 5  | Mode (mode)                          | 0 – disabled, 1 – status only, 2 – report on violations                               |
| 6  | Alarm delay (almdly)                 | 0-65535 seconds   |
| 7  | Report on return to normal (repnorm) | 0 – disabled<br>1 – enabled, report when the channel returns to the normal condition. |
| 8  | Report Flags (repflgs)               | Reserved  |
| 9  | Normal state (norm)                  | 0 – normally open, 1 – normally closed  |
| 10 | Starts limit (stalm)                 | 0-999999  |
| 11 | Run Limit (runlim)                   | 0-999999  |
| 12 | Alarm Relay (almrly)                 | Channel number of relay to control when in alarm (0,151-158)                          |

Example:

Via debug menu:

```
9,202,9,1,5,2,6,15<CR><LF>
```

Channels 52, normally closed, report alarms, alarm delay is 15 seconds.



**Field Type Codes for Report Flags (12)**  
(use optional <i>, to specify channel number)

|   |  |   |
|---|--|---|
| 3 | Periodic reports (per)<br>Reported at report rate<br>specified in Sites<br>configuration | 0 – not included<br>1 – current value<br>2 – current value, cycle counts, run-time duration value, min and<br>max   |
| 4 | End of Day reports (eod)   | 0 – not included<br>1 – current value, cycle counts, run- time duration value or flow<br>totalization<br>2 – current value, cycle counts, run-time duration value or flow<br>totalization |
| 6 | Alarm reports (alm)  | 0 – not included<br>1 – current value<br>2 – current value, flow totalization value, min and max  |

**Note:** Digital values      Counts and Duration values are only reported if their value is > 0.  
 Analog values      Total, Max and Min are only reported if the value is > 0.

Example:

Via debug port:

12, 21, 3, 0, 4, 2, 6, 2<CR><LF>

Report flags for physical digital channel 21,  
 Do not report anything in the periodic report,  
 Report the current state and any duration or count data at the end of the day or when an alarm occurs.



| Field Type Codes for Pump (20) |                             |  |
|--------------------------------|-----------------------------|--|
| 1                              | Pump 1 run channel (p1ch)   | Select a digital input, physical or Modbus. Typically the first physical digital channel, 21   |
| 2                              | Pump 2 run channel (p2ch)   | Select a digital input, physical or Modbus. Typically the first physical digital channel, 22   |
| 3                              | Pump 3 run channel (p3ch)   | Select a digital input, physical or Modbus. Typically the first physical digital channel, 23 (if 3 pumps are being used).  |
| 4                              | Tank level channel (lvlch)  | Select an analog input, physical or Modbus. Typically the first physical analog channel, 51.   |
| 5                              | Inflow time window (infwin) | Amount of time used to compute the inflow rate. This value must be less than the amount of time between when pumps go off and can go back on.<br>Specified in seconds, 0 – 9999. |
| 6                              | Tank area (area)            | Cross sectional area of the tank.<br>Specified in square feet, 0 - 9999.9999.  |
| 7                              | Inflow channel (infch)      | Channel to save the inflow calculated rate into. Typically the first computed analog channel, 171.<br>The total daily inflow is in the totalizer for this channel.               |
| 8                              | Outflow channel (outfch)    | Channel to save the outflow calculated volume into. Typically the second computed analog channel, 172.<br>The total daily outflow is in the totalizer for this channel.          |

Example:

---

**Note:** Set channels for a two pump station.

---

Via debug port:

```
20,1,21,2,22,4,51,5,15,6,15.7,171,8,172<CR><LF>
```

Tank cross-sectional area for a 5' diameter tank.

---



**Field Type Codes for Operator (21)**  
(use optional <i>, to specify operator number)

|   |               |                                    |
|---|---------------|------------------------------------|
| 1 | Operator Name | Name of an operator, 30 characters |
|---|---------------|------------------------------------|

Example:

---

**Note:** Set three operator names.

---

Via debug port:

```
21,1,1,John Doe<CR><LF>  
21,1,2,Roger Thompson<CR><LF>  
21,1,3,Carla Brindal<CR><LF>
```

---



## 16 Technical Support

For remote and communication control systems support, parts and repair, or technical support, visit us online at:  
[www.cattron.com/contact](http://www.cattron.com/contact).



## 17 Certifications

UL: Pending

Industry Canada registration number: IC: 4825A-SCOUT

CE Mark

FCC



## 18 Glossary

| Item                         | Description   |
|------------------------------|---|
| <b>Access Code</b>           | A four-character code that is used to limit access to any Control or Programming capabilities in Aquavx.  |
| <b>Action (ACTN) Command</b> | Commands that can be sent OTA or via SMS to request Aquavx to perform a specific action. All commands sent via SMS are acknowledged back to the sender of the SMS.  |
| <b>Analog Input Type</b>     | Specifies the type of input that the A/D converter is hardware configured to accept. Supported types are 0-20 mA, 4-20 mA, 0-5 VDC and 1-5 VDC.   |
| <b>Add Checksum</b>          | If enabled, the reports sent to the internet back-end have a CRC-16 appended to the message. The Checksum is appended to the very end of the message, before a <CR><LF>, if the message is terminated using those characters.   |
| <b>Alarm Delay</b>           | Consecutive seconds an input needs to exceed a Limit before it goes into alarm. Allowable range is 0-65535 seconds. Default is 3 seconds. Channel state goes to NotNorm until the input returns to Normal or into Alm.  |
| <b>Alarm Types</b>           | <p>Alarm notifications are generated either from any channel or from a timed event. System channels are treated as Digital channels.</p> <p>The Digital channels have three types of alarms:</p> <ul style="list-style-type: none"> <li>• Transition to: Closed or Open</li> <li>• Duration (Run) Limit exceeded before midnight</li> <li>• Starts (Cycles) Limit exceeded before midnight</li> </ul> <p>Analog Inputs have three types of alarms, which are triggered on the transition into each state.</p> <ul style="list-style-type: none"> <li>• High – exceeds high limit</li> <li>• Normal</li> <li>• Low – exceeds low limit</li> <li>• Failsafe – exceeds high or low failsafe limits</li> </ul> <p>Each of these alarms is independent of the other.</p> |
| <b>APN</b>                   | Internet address provided by the cellular provided for Aquavx to connect to for GPRS communication.   |
| <b>AutoACK</b>               | <p>If set to Auto, Aquavx expects every transmission to the Internet application to be positively acknowledged according to the Protocol being used. If the message is not acknowledged, Aquavx sends the message again after a predefined time delay.</p> <p>Any messages not successfully sent are stored and forwarded when communication is again successful.</p> <p>If set to None, Aquavx assumes the message was received and does not save the record in the store and forward.</p> <p>If set to Demand, the value of 100000 is added to the Event Code.</p>  |
| <b>AutoScroll</b>            | Enables or Disables the automatic Scroll display.   |



| Item                   | Description   |
|------------------------|---|
| <b>AutoSendConfig</b>  | Enables or Disables Aquavx automatically sending any configuration change to the internet hosted-services. The configuration is sent after a time delay from the last change.   |
| <b>AutoTimeSet</b>     | If set to 1 (enabled), Aquavx automatically sets its real-time clock based on GPS time if available or via government-managed websites that provide exact time. If via GPS, then the Time Zone and Daylight Saving are ignored. The time is checked every day at midnight and adjusted if it is off more than 15 seconds. If set to 0 (disabled), the real-time clock time is not automatically set.  |
| <b>Auto Updates</b>    | When enabled, Aquavx automatically sends Reports to the internet back-end application according to the Report Rate.   |
| <b>Baud Rate</b>       | The serial port baud rate for communication via the Serial Ports. Aquavx supports from 1200 to 115200 baud.   |
| <b>Call Delay</b>      | This parameter sets the minimum amount of time between sending Reports out via Cell or over the serial port. This parameter is generally used to limit the speed at which connections are made to the wireless network to prevent too frequent network usage in the event that a monitored condition is cycling rapidly.  |
| <b>Channel Mode</b>    | Indicates whether the channel is Disabled, Status Only or one of the Alarm modes. <ul style="list-style-type: none"> <li>• Disabled – the channel is not being scanned or processed</li> <li>• Status Only – the channel is being scanned but not evaluated for alarms (both Digital and Analog)</li> <li>• Call on Violation <ul style="list-style-type: none"> <li>- Digital – goes into alarm when the channel goes from the Normal setting to the Non-normal setting (e.g., from Open to Closed on a Normally Open channel)</li> <li>- Analog – goes into alarm when the value exceeds either the Low or High Limits</li> </ul> </li> </ul> |
| <b>Channel Name</b>    | A 20-character name associated with a channel.  |
| <b>Checksum</b>        | When enabled, a CRC-16 is computed over the entire set of data being sent, including the <CR><LF>. The CRC-16 is formatted into human-readable form. The range is 0000-FFFF.  |
| <b>Dampen ADC</b>      | If enabled, the analog input channel is internally averaged to remove noise.  |
| <b>Databits</b>        | Length of the data byte for serial communications. Value is 7 or 8.   |
| <b>Daylight Saving</b> | If set to No, Aquavx will NOT adjust time for daylight saving. If set to Yes, Aquavx WILL adjust.   |
| <b>Debug Port</b>      | If enabled, then the serial ports can be connected to a laptop or PC for viewing diagnostics (status, event log, etc.) or for programming.<br>The laptop/PC should use HyperTerminal or some other terminal emulation program.<br>When connected, press the Enter key. A menu of options is displayed.  |
| <b>DelimiterChar</b>   | The delimiter character used in the protocol to send data to the internet hosted-service. The default is “.”.   |





| Item                     | Description   |    |           |    |                |    |                |   |                |   |     |    |           |   |     |   |    |    |                |   |     |    |    |    |           |   |     |    |           |    |               |   |     |    |           |    |            |   |           |  |  |  |  |
|--------------------------|---|----|-----------|----|----------------|----|----------------|---|----------------|---|-----|----|-----------|---|-----|---|----|----|----------------|---|-----|----|----|----|-----------|---|-----|----|-----------|----|---------------|---|-----|----|-----------|----|------------|---|-----------|--|--|--|--|
| <b>Digital Channel</b>   | A digital channel is one that can take on a value of on or off. This refers to system channels that have only these two states, physical and Modbus Digital inputs.   |    |           |    |                |    |                |   |                |   |     |    |           |   |     |   |    |    |                |   |     |    |    |    |           |   |     |    |           |    |               |   |     |    |           |    |            |   |           |  |  |  |  |
| <b>Disabled</b>          | Channel is not scanned or evaluated for alarms.   |    |           |    |                |    |                |   |                |   |     |    |           |   |     |   |    |    |                |   |     |    |    |    |           |   |     |    |           |    |               |   |     |    |           |    |            |   |           |  |  |  |  |
| <b>Display Precision</b> | Number of digits to the right of the decimal. The default is 2, but can be adjusted from 0 to 6.<br>For example, if the Display Precision is 3, then values are presented as: xx.xxx.   |    |           |    |                |    |                |   |                |   |     |    |           |   |     |   |    |    |                |   |     |    |    |    |           |   |     |    |           |    |               |   |     |    |           |    |            |   |           |  |  |  |  |
| <b>Dur Limit</b>         | Duration Limit – On a digital channel, any time the input transitions from the Normal condition to the non-Normal condition, Aquavx accumulates the total non-Normal time for the day.<br>The total time is reset at midnight. If the total time exceeds the Dur Limit before midnight, a message is sent with the appropriate Duration Event code for the channel.   |    |           |    |                |    |                |   |                |   |     |    |           |   |     |   |    |    |                |   |     |    |    |    |           |   |     |    |           |    |               |   |     |    |           |    |            |   |           |  |  |  |  |
| <b>End of Day</b>        | Specify a time as HH:MM that ends a 24 hour period. When this time is met, the statistics for the previous 24 hours are reported to Aquavx.   |    |           |    |                |    |                |   |                |   |     |    |           |   |     |   |    |    |                |   |     |    |    |    |           |   |     |    |           |    |               |   |     |    |           |    |            |   |           |  |  |  |  |
| <b>Engineering Units</b> | <table border="0"> <tbody> <tr> <td>0</td> <td>none</td> <td>7</td> <td>rpm</td> <td>13</td> <td>km (kilometer)</td> </tr> <tr> <td>1</td> <td>% (percentage)</td> <td>8</td> <td>psi</td> <td>14</td> <td>L (liter)</td> </tr> <tr> <td>2</td> <td>ppm</td> <td>9</td> <td>°C</td> <td>15</td> <td>kL (kiloliter)</td> </tr> <tr> <td>3</td> <td>gal</td> <td>10</td> <td>°F</td> <td>16</td> <td>gm (gram)</td> </tr> <tr> <td>4</td> <td>gpm</td> <td>11</td> <td>in (inch)</td> <td>17</td> <td>kg (kilogram)</td> </tr> <tr> <td>5</td> <td>gph</td> <td>12</td> <td>m (meter)</td> <td>18</td> <td>lb (pound)</td> </tr> <tr> <td>6</td> <td>ft (feet)</td> <td></td> <td></td> <td></td> <td></td> </tr> </tbody> </table> | 0  | none      | 7  | rpm            | 13 | km (kilometer) | 1 | % (percentage) | 8 | psi | 14 | L (liter) | 2 | ppm | 9 | °C | 15 | kL (kiloliter) | 3 | gal | 10 | °F | 16 | gm (gram) | 4 | gpm | 11 | in (inch) | 17 | kg (kilogram) | 5 | gph | 12 | m (meter) | 18 | lb (pound) | 6 | ft (feet) |  |  |  |  |
| 0                        | none  | 7  | rpm       | 13 | km (kilometer) |    |                |   |                |   |     |    |           |   |     |   |    |    |                |   |     |    |    |    |           |   |     |    |           |    |               |   |     |    |           |    |            |   |           |  |  |  |  |
| 1                        | % (percentage)  | 8  | psi       | 14 | L (liter)      |    |                |   |                |   |     |    |           |   |     |   |    |    |                |   |     |    |    |    |           |   |     |    |           |    |               |   |     |    |           |    |            |   |           |  |  |  |  |
| 2                        | ppm   | 9  | °C        | 15 | kL (kiloliter) |    |                |   |                |   |     |    |           |   |     |   |    |    |                |   |     |    |    |    |           |   |     |    |           |    |               |   |     |    |           |    |            |   |           |  |  |  |  |
| 3                        | gal   | 10 | °F        | 16 | gm (gram)      |    |                |   |                |   |     |    |           |   |     |   |    |    |                |   |     |    |    |    |           |   |     |    |           |    |               |   |     |    |           |    |            |   |           |  |  |  |  |
| 4                        | gpm   | 11 | in (inch) | 17 | kg (kilogram)  |    |                |   |                |   |     |    |           |   |     |   |    |    |                |   |     |    |    |    |           |   |     |    |           |    |               |   |     |    |           |    |            |   |           |  |  |  |  |
| 5                        | gph   | 12 | m (meter) | 18 | lb (pound)     |    |                |   |                |   |     |    |           |   |     |   |    |    |                |   |     |    |    |    |           |   |     |    |           |    |               |   |     |    |           |    |            |   |           |  |  |  |  |
| 6                        | ft (feet)   |    |           |    |                |    |                |   |                |   |     |    |           |   |     |   |    |    |                |   |     |    |    |    |           |   |     |    |           |    |               |   |     |    |           |    |            |   |           |  |  |  |  |
| <b>Event Log</b>         | The event log stores the 200 most recent events that have occurred in Aquavx. The information that is stored is alarm conditions, call-outs and call- ins. All events are logged with the following information: <ul style="list-style-type: none"> <li>• &lt;Date and Time&gt; &lt;Event logged information&gt;</li> </ul>   |    |           |    |                |    |                |   |                |   |     |    |           |   |     |   |    |    |                |   |     |    |    |    |           |   |     |    |           |    |               |   |     |    |           |    |            |   |           |  |  |  |  |
| <b>File</b>              | Filename for the FTP service to use to Get or Put.  |    |           |    |                |    |                |   |                |   |     |    |           |   |     |   |    |    |                |   |     |    |    |    |           |   |     |    |           |    |               |   |     |    |           |    |            |   |           |  |  |  |  |
| <b>Full Scale</b>        | Specifies the full scale value in engineering units for the on-board analog input signal, when the signal is at its highest detectable value.   |    |           |    |                |    |                |   |                |   |     |    |           |   |     |   |    |    |                |   |     |    |    |    |           |   |     |    |           |    |               |   |     |    |           |    |            |   |           |  |  |  |  |
| <b>High Limit</b>        | A value that defines a limit against which the current analog value is compared to determine if the associated Channel is in alarm. When the current analog value rises above this limit for the Alarm Delay number of seconds, the Channel is considered to be in Alarm. If the Channel Mode is set to Call on Violation, then a Report is sent to the server.<br>This value is entered as a real number (e.g., 100.25).   |    |           |    |                |    |                |   |                |   |     |    |           |   |     |   |    |    |                |   |     |    |    |    |           |   |     |    |           |    |               |   |     |    |           |    |            |   |           |  |  |  |  |
| <b>IP (FTP)</b>          | Internet address of the FTP server; can be specified as xxx.xxx.xxx.xxx or a DNS.   |    |           |    |                |    |                |   |                |   |     |    |           |   |     |   |    |    |                |   |     |    |    |    |           |   |     |    |           |    |               |   |     |    |           |    |            |   |           |  |  |  |  |
| <b>IP (Cell)</b>         | Internet address of the back-end application; can be specified as xxx.xxx.xxx.xxx or a DNS.   |    |           |    |                |    |                |   |                |   |     |    |           |   |     |   |    |    |                |   |     |    |    |    |           |   |     |    |           |    |               |   |     |    |           |    |            |   |           |  |  |  |  |



| Item                      | Description   |
|---------------------------|---|
| <b>Low Limit</b>          | A value that defines a limit against which the current analog value is compared to determine if the associated Channel is in alarm. When the current analog value falls below this limit for the Alarm Delay number of seconds, the Channel is considered to be in Alarm. If the Channel Mode is set to Call on Violation, then a Report is sent to the server.<br>This value is entered as a real number (e.g., 100.25). |
| <b>Max and Min</b>        | Aquavx keeps track of the Max and Min values for all analog channels for each day. These values can be reported using the Aquavx Protocol in Periodic, Alarm and End of Day reports. These values are reset after being sent at the end of the day.   |
| <b>Modbus</b>             | Protocol supported by Aquavx to communicate via a serial port to another device, typically a PLC or PC.   |
| <b>Mode (channel)</b>     | Alarm mode: <ul style="list-style-type: none"> <li>• Disabled – channel is not evaluated or monitored</li> <li>• Status Only – channel is monitored but not compared to limits (thresholds)</li> <li>• Call On Violation – channel is monitored, compared to limits and messages sent if limits are violated</li> </ul>   |
| <b>Mode (FTP)</b>         | Active or Passive. Usually indicates if the FTP server is behind a firewall (active) or not.  |
| <b>Mode (serial port)</b> | For each serial port, the Mode specifies the current function of that port. For example, Cell, Serial, Modbus Master, Debug, etc.   |
| <b>Next Call Delay</b>    | Amount of time Aquavx waits until the next transmission is sent to the internet application. This is used to regulate the frequency of data being sent to the internet application.   |
| <b>Norm</b>               | Indicates the current state of a channel. Viewable when requesting a Report from the Debug Menu or a Daily Report via FTP.<br>Norm means that the current value has not exceeded any of the limits specified.   |
| <b>Normal</b>             | Specifies the Normal condition for a digital input channel. Valid values are: Normally Open or Normally Closed.   |
| <b>Notnorm</b>            | Indicates the current state of a channel. Viewable when requesting a Report from the Debug Menu or a Daily Report via FTP.<br>Notnorm means that the current value has exceeded one of the limits specified.  |
| <b>Parity</b>             | Parity on the dataframe for the serial ports. Values are None, Odd or Even.   |
| <b>Path</b>               | Path to a folder on the FTP site to Get files from or Put files to.   |
| <b>PINGrate</b>           | Rate at which Aquavx sends a PING to the server to maintain an always-on connection.  |
| <b>Port (FTP)</b>         | FTP sites are usually port 21. If your FTP site is different, enter the appropriate port number.  |
| <b>Port (cell)</b>        | Port number of the UDP or TCP application connection. Valid from 0-65535.   |
| <b>Protocol</b>           | Specify UDP or TCP.   |
| <b>PWD</b>                | Password for APN or FTP connection, if required by cellular service provider.   |



| Item                            | Description  |
|---------------------------------|--|
| <b>Rain Fall</b>                | Aquavx can compute a total rainfall amount for the day and report the current total rainfall and daily rainfall. It is reset at the end of the day.<br>The maximum input frequency is 1 tip per second (1 Hz). The minimum pulse width of the tip is 40 ms.  |
| <b>Reg Addr</b>                 | Register address – the Modbus register address for a channel in Aquavx.  |
| <b>Register Number</b>          | A valid Modbus register number from 1 to 9999.<br>Some PLCs refer to registers as a combination of the Register Type and the Register Number. For example, a PLC may reference register 40100. Aquavx would be a Modbus Analog Read Holding and Register Number 100.   |
| <b>Report Rate</b>              | The frequency that periodic reports are sent to the server. Periodic reports include values specified by the Report Flags configuration.   |
| <b>Request Mode</b>             | Used for Modbus communication to optimize the packing of analog and digital channels being read. When enabled, Aquavx attempts to pack the data to minimize the serial traffic. Valid values are Block (try to pack the data) or Single (request each channel separately).   |
| <b>Reset Modem</b>              | An OTA command that cycles the power on the Cell Modem.  |
| <b>Reset to System Defaults</b> | Performing this function erases all user programming and sets Aquavx back to the factory settings.<br>This can be accomplished through the Debug menu in the Maintenance Section or using the Reset command (256).   |
| <b>RespTout</b>                 | The Response Timeout is the maximum amount of time Aquavx waits for a response from the serially connected device when it transmits a message. Value ranges from 100 to 10000 ms.  |
| <b>ScanRate</b>                 | The rate Aquavx scans the Modbus channels for data. From 1 to 60 seconds.<br><b>Note:</b> Be careful not to make the Scan Rate longer than the Alarm Delay on the Modbus channels.   |
| <b>Service Provider</b>         | Provider of the SIM card. AT&T, T-Mobile, KORE, etc. KORE is the default.  |
| <b>Site Name</b>                | A 20-character name that the user enters to identify the unit.   |
| <b>Slave ID</b>                 | Modbus ID number of the Slave device.<br>Modbus uses a Master to initiate communication to a number of Slaves.   |
| <b>SMS Commands</b>             | SMS commands can be issued to Aquavx to perform certain actions. When an SMS command is received, an Acknowledgement (ACK) or Not Acknowledgement (NAK) is sent to the internet to indicate if the command was performed   |
| <b>ss</b>                       | Signal strength of the Cell. Even if the Cell modem has not registered on the Cell network, there is a Signal Strength available. <ul style="list-style-type: none"> <li>• A value less than 6 provides marginal and intermittent connections</li> <li>• A value between 6 and 9 provides an adequate connection</li> <li>• A value greater than 9 provides a reliable connection</li> </ul> |
| <b>StartMsgChar</b>             | Start Message Character used by the protocol to send data to the internet hosted-service. The default is “&”.  |



| Item               | Description  |
|--------------------|--|
| <b>Status Only</b> | Analog and digital channel is scanned but not evaluated for alarms.  |
| <b>StopBits</b>    | Number of bits to end the dataframe on serial communications. Value is 1 or 2.   |
| <b>Time Zone</b>   | Specifies the time zone in which Aquavx is operating. This is only used if there is no GPS being used.                                       |
| <b>USR</b>         | Username for APN or FTP connection, if required by cellular service provider.  |
| <b>Zero Scale</b>  | Specifies the zero scale value in engineering units for the on-board analog input signal, when the signal is at its lowest detectable value. |



## 18.1 Cell Statuses

| Status         | Meaning   |
|----------------|---|
| Cell lockout   | <p>Aquavx has determined that the battery does not have enough power to use the cellular modem. Aquavx enters into a Lockout mode to allow it time to charge the battery without the cellular modem powered up.</p> <p>Aquavx also goes into Lockout when four or more consecutive modem Power Off/Power On resets have occurred, with each reset being within 120 seconds of the previous reset. Modem Power Off/Power On cycles under Aquavx control do not contribute to the count of four.</p> <p>Aquavx keeps the cellular power off for an hour, then powers it up to determine if the battery has enough power; if not, the process is repeated.</p> |
| Cell Resynch   | <p>Synchronization between Aquavx and the cellular signal has been lost – that can be due to change of baud rate or APN connection.</p> <p>Aquavx automatically detects the loss and tries to re-establish communication.</p>   |
| Cell CyclePwr  | <p>Aquavx periodically turns the power to the cellular modem off to fully re-establish communication to the cellular tower.</p>   |
| Cell Setup     | <p>Aquavx has started to program the cellular modem for operation.</p>  |
| Cell Idle1     | <p>During the cellular modem programming sequence, there is a point that Aquavx is waiting for the modem to respond that can take up to 60 seconds.</p>   |
| Cell Configure | <p>The cellular modem has been requested to save all programming commands.</p>  |
| Cell Idle2     | <p>During the cellular modem programming sequence, there is a point that Aquavx is waiting for the modem to respond that can take up to 60 seconds.</p>   |
| Cell Connect   | <p>The cellular modem has connected to the cellular network.</p>  |
| Cell Ready     | <p>The cellular modem has responded that is it ready to receive data.</p>   |
| Err comm       | <p>Error in serial port communications with either the cellular modem or Modbus devices.</p>  |
| Cell SendData  | <p>Aquavx is currently sending data to the internet hosted-service.</p>   |
| Cell Ping      | <p>Aquavx is sending a PING packet to the internet hosted-service.</p>  |
| Cell ADIP      | <p>Remote diagnostic Over-The-Air (OTA) tool is being used.</p>   |
| Cell FTP       | <p>FTP session in progress.</p>   |
| Cell SMS       | <p>Aquavx is receiving an SMS command.</p>  |
| Cell GetTime   | <p>Aquavx is getting time from Internet time servers.</p>   |
| Cell noACK     | <p>No ACK was received from the internet hosted-service for the last report.</p>  |
| Cell delay     | <p>Aquavx is waiting for the Next Call Delay period before the next report can be sent to the internet hosted-service.</p>  |



Due to continuous product improvement, the information provided in this document is subject to change without notice.

**Cattron Support**

For remote and communication control systems support, parts and repair, or technical support, visit us online at:  
[www.cattron.com/contact](http://www.cattron.com/contact)

Cattron North America Inc., 655 N River Rd NW, Suite A, Warren, OH 44483