



## Introduction Guide

Release R210



## PREFACE

---

### General

The CIU 888 is Honeywell's next generation *Communication Interface Unit*. CIU 888 is the crucial link between tank gauging instruments and control room systems. It provides operators with reliable and accurate real-time tank inventory data 24 hrs a day, 7 days a week.

### Purpose of this manual

The purpose of this manual is to provide an overview of the main features and functions of the CIU 888.

### Target audience of this manual

This manual is primarily intended for:

- Service technicians who are responsible for commissioning and configuring the CIU 888, diagnosing, troubleshooting, servicing, and maintaining the CIU 888
- IT managers who are responsible for implementing and maintaining the technology infrastructure of the company's network
- System integrators who are responsible for designing and verifying the customer's tank farm operations system in which the CIU 888 provides the tank inventory data
- System administrators who are responsible for management of the CIU 888 and the site network

### CIU 888 documentation suite

The CIU 888 documentation suite includes the following documents:

- Introduction Manual (Part No. 4417591)
- Installation Manual (Part No. 4417590)
- Configuration Manual (Part No. 4417584)
- Protocol Manual - Modbus Host (Part No. 4417588)
- Protocol Manual - CIU Emulation (Part No. 4417589)
- Sealing Guide (Part No. 4417595)
- System Administration Manual (Part No. 4417598)
- Security Manual (Part No. 4417597)
- Firmware Upgrade Manual (Part No. 4417596)
- Troubleshooting & Maintenance Guide (Part No. 4417594)
- Ensite Pro to CIU 888 Migration Manual (Part No. 4417593)

*This page is intentionally left blank*

---

## Table of Contents

---

### TABLE OF CONTENTS

---

<b>Preface</b> .....	<b>i</b>
General .....	i
Purpose of this manual .....	i
Target audience of this manual .....	i
CIU 888 documentation suite .....	i
<b>Table of Contents</b> .....	<b>iii</b>
<b>CHAPTER 1 Introduction</b> .....	<b>1-1</b>
1.1 Next generation CIU .....	1-1
1.2 Full support of installed base .....	1-2
1.3 Designed for users .....	1-4
1.3.1 Ring of light .....	1-5
1.3.2 CIU 888 display and navigation keys .....	1-5
1.3.3 CIU 888 Web interface .....	1-7
1.4 Increased IT security and safety .....	1-7
1.5 Delivering ultimate connectivity .....	1-8
1.5.1 Ethernet ports .....	1-9
1.5.2 Serial host ports .....	1-11
1.5.3 Ethernet host ports .....	1-11
1.5.4 Option slots .....	1-12
1.5.5 USB ports .....	1-12
1.5.6 Relays .....	1-14
1.5.7 Other connections .....	1-14
1.6 Up-to-date regulatory compliance .....	1-14
1.7 Maximizing data availability through full redundancy .....	1-15
1.8 Remote access for safe and secure support of gauges .....	1-15
<b>CHAPTER 2 Technical Specifications and Dimensions</b> .....	<b>2-1</b>
2.1 Technical Specifications - Functional (Software version R140) .....	2-1
2.2 CIU 888 Option Board Specifications .....	2-3
2.3 Technical Specifications - Hardware .....	2-4
2.4 Dimensional drawing .....	2-6
<b>APPENDIX A List of Abbreviations</b> .....	<b>A-1</b>

---

**Table of Contents**

---

*This page is intentionally left blank*

## CHAPTER 1 INTRODUCTION

---

### 1.1 Next generation CIU

Successor to the CIU 880 Prime and Plus, the CIU 888 is the crucial link between the gauging instruments on bulk liquid storage tanks and the control, monitoring and safety systems in the site control room. The CIU 888 provides operators with reliable and accurate real-time tank inventory data 24 hours a day, 7 days a week, increasing the site's effectiveness and productivity while reducing costs.



FIGURE 1-1

The CIU 888

---

The CIU 888 serves as data acquisition unit of tank gauging instruments, and continuously scans gauge data. All measured data is used to calculate accurate tank inventory data using international standardized methods of calculation, such as API and ASTM among others.

All measured and calculated data is instantly available for use by host applications, such as tank inventory systems, Distributed Control Systems (DCSs), Programmable Logic Controllers (PLCs), and others via multiple and dedicated host links and interfaces. Support of multiple host interfaces guarantees convenient and reliable connectivity between the installed field instruments and the systems in the control room.

1.2 Full support of installed base

Building on the strengths of its predecessors, the CIU 888 can be migrated into an existing tank inventory system with minimal effort. A single CIU 888 can replace a set of CIU 880 Plus and Prime, a single CIU 880 Prime or a single CIU 858/SmartLink.

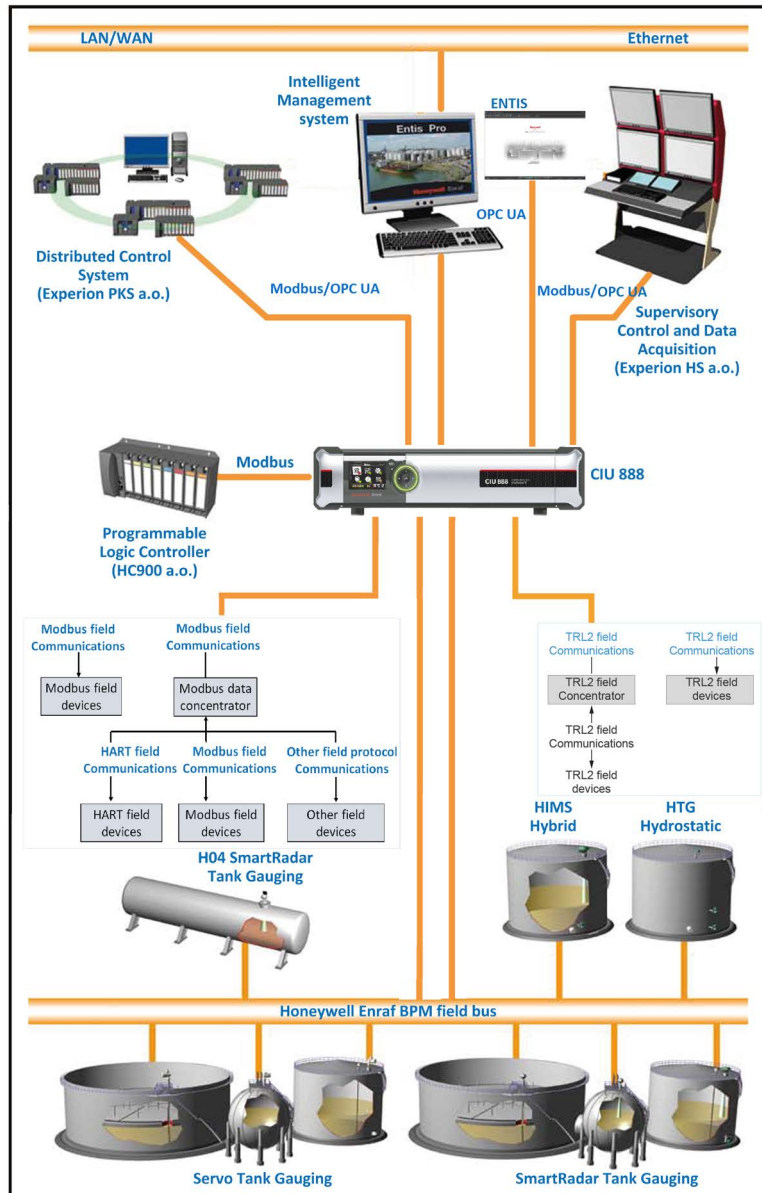

FIGURE 1-2

Tank gauging system with CIU 888 as crucial link between field and control room



## Introduction

The advantages of the CIU 888 become clear when comparing the CIU 888 to previous generations in the CIU series, as shown in TABLE 1-1.

TABLE 1-1 Comparison between CIU 888 and previous generations in CIU series

Field lines	CIU 858	Smart Link	CIU Prime	CIU Plus	CIU 888 R101.5	CIU 888 R103	CIU 888 R120	CIU 888 R130	CIU 888 R140/ R150/ R160	CIU 888 R161	CIU 888 R210
<i>BPM</i>	3	3	4	2	Up to 4	Up to 6	Up to 6	Up to 6	Up to 6	Up to 6	Up to 6
	✓	✓	✓	✗	✓	✓	✓	✓	✓	✓	✓
<i>TRL/2 Modbus</i>	✗	✗	✗	✗	✗	✗	✓	✓	✓	✓	✓
<i>Serial GPU</i>	✗	✗	✓	✗	✓	✓	✓	✓	✓	✓	✓
<i>Serial Modbus</i>	✗	✗	✗	✓	✗	✓	✓	✓	✓	✓	✓
<b>Serial Host links</b>	1	2	2	4	2 to 4	2 to 6	2 to 6	2 to 6	2 to 6	2 to 6	2 to 6
<i>Serial GPU</i>	✓	✓	✓	✗	✓	✓	✓	✓	✓	✓	✓
<i>Serial Modbus</i>	✗	✗	✓	✓	✓	✓	✓	✓	✓	✓	✓
<b>Ethernet Host links</b>	✗	✗	✗	✗	✗	✗	✗	3	3	3	3
<i>Modbus TCP/IP</i>	✗	✗	✗	✗	✗	✗	✗	✓	✓	✓	✓
<i>OPC UA</i>	✗	✗	✗	✗	✗	✗	✗	✗	✗	✗	✓
<b>Separate service port</b>	✗	✗	✗	✗	✓	✓	✓	✓	✓	✓	✓
<b>Volume correction</b>	✗	✗	✗	✓	✓	✓	✓	✓	✓	✓	✓
<b>LM sealing</b>	✗	✓	✓	✓	✓	✓	✓	✓	✓	✓	✓
<b>No. of emulation host ports</b>	✓	✓	1	✗	1	Up to 4	Up to 4	Up to 4	Up to 4	Up to 4	Up to 4
<b>No. of Tanks</b>	✗	✗	50	50	50	80	80	80	80	80	80
<b>Native profiles support</b>	✗	✗	✗	✗	✗	✗	✗	✗	✓	✓	✓
<b>VPN port for servicing (Configurable IP Address)</b>	✗	✗	✗	✗	✗	✗	✗	✗	✓	✓	✓
<b>Ethernet based Wireless device scanning</b>	✗	✗	✗	✗	✗	✗	✗	✗	✗	✓	✓

---

## Introduction

---

Additional Inventory calculations	x	x	x	x	x	x	x	x	x	x	✓
-----------------------------------	---	---	---	---	---	---	---	---	---	---	---

*NOTE: 10 OPC UA clients are supported.*

*NOTE: 15 Modbus TCP/IP clients are supported.*

### 1.3 Designed for users

One of the most striking features of the CIU 888 is its user-friendliness. The CIU 888's user interface guarantees an intuitive operation and makes sure that users do not suffer from information overload and are presented with the essentials, where it is also possible to analyze the details easily.

#### 1.3.1 Ring of light

The ring of light located at the front of the CIU 888, as shown in FIGURE 1-3, immediately draws the attention of the user. It provides a clear indication of the actual CIU 888 status based on NAMUR color coding.



FIGURE 1-3

CIU 888: Ring of light

---

### 1.3.2 CIU 888 display and navigation keys

The LCD display, as shown in FIGURE 1-4, provides more detailed information about the status of CIU 888.

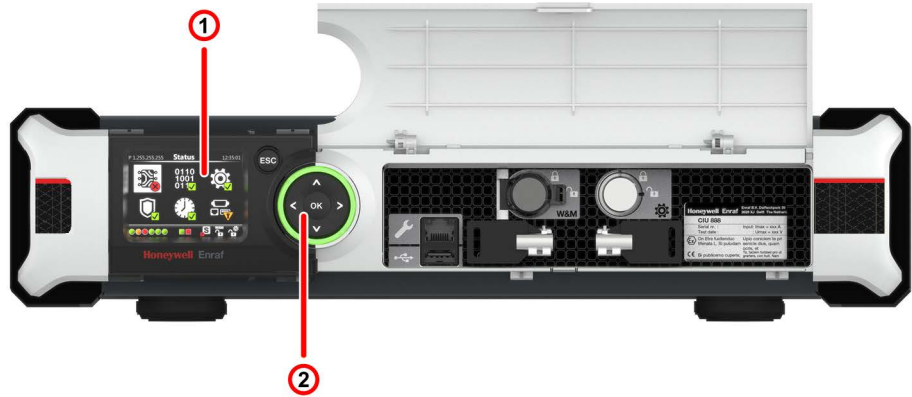

FIGURE 1-4

CIU 888: Display (1) and navigation keys (2)

---

The main screen of the display, called the *Status Dashboard*, gives users quick feedback on the operational state and health of the CIU 888 and its interfaces. Additionally, the *Status Dashboard* serves as a portal to more detailed status information and configuration settings, which can be accessed using the navigation keys.



FIGURE 1-5

CIU 888 display: Status Dashboard

---

### 1.3.3 CIU 888 Web interface

The CIU 888 Web interface, shown in FIGURE 1-6, can be accessed for in-depth diagnostics, monitoring and service of the CIU 888.

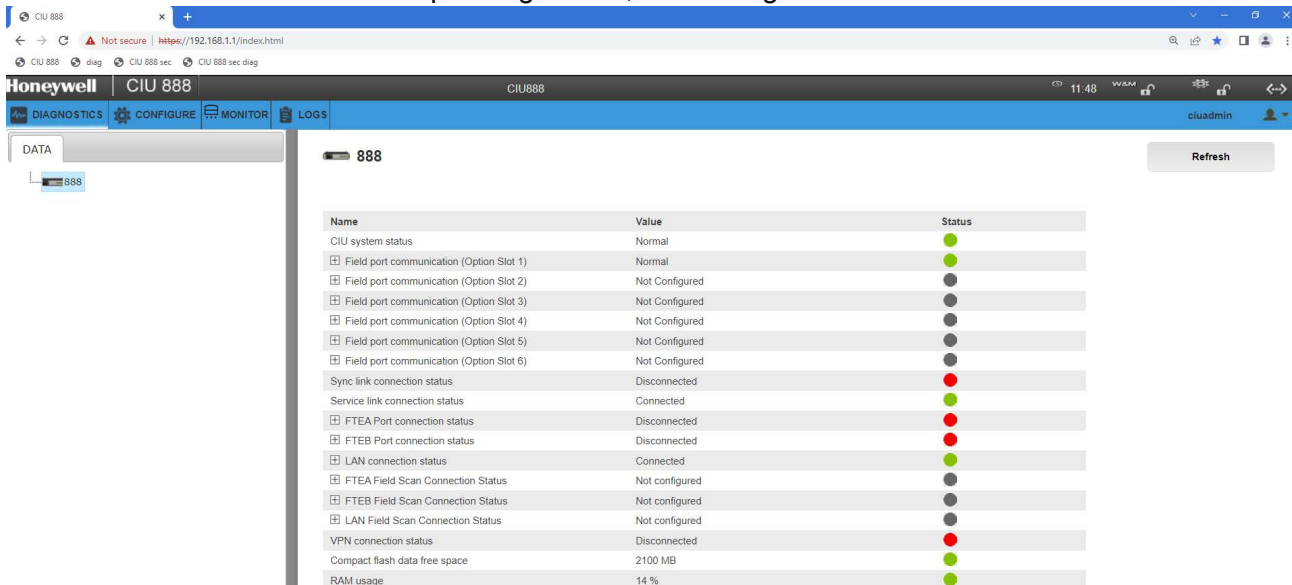

FIGURE 1-6

CIU 888 Web interface

The Web interface is easily accessible via a standard browser and allows users to perform a range of tasks, including commissioning and configuration of the CIU 888 and performing system diagnostics. For more information see the Configuration Manual (4417584).

### 1.4 Increased IT security and safety

The CIU 888 is designed from a multi-layered approach to IT security, in which multiple security measures are placed throughout the device. Should one security measure not be able to avert a security breach, others continue to protect resources and data thereby preventing/limiting any potential damage.

The security measures implemented in the CIU 888 vary in nature, but fundamentally they all share the same goal: protecting the confidentiality, integrity and availability of data.

Below a non-exhaustive list of examples of security measures implemented in the CIU 888:

- Full network segregation via integrated firewall
- User access to the CIU 888 and the CIU 888 Web interface restricted to authorized users
- Use of cyclic redundancy checks (CRCs) to indicate the integrity of site configuration data

- Option to seal the CIU 888 to indicate that the system settings are unchanged after verification and to be used for LM-certified applications for inventory control, custody transfer, accounting and duties
- Hardened CIU 888 boxes with a low susceptibility to virus and malware infestation to ensure uninterrupted data availability, and availability of critical applications and services.
- Auto-disabled USB ports preventing accidental virus infection or distribution of malware through the use of USB drives
- Ports are enabled only after configuration. Only the required ethernet ports are enabled.

### 1.5 Delivering ultimate connectivity

Where serial interfaces used to be the standard also in the industry, Ethernet based networks are more common today on several levels. Unlike its predecessors, the CIU 888 not only fully supports current standard interfaces, but also supports Ethernet connectivity. With the right approach to security, possibilities to share data with other applications are easily in reach. Reliable, accurate data can help business applications or planning, reconciliation, etc. to become more effective and efficient.

#### 1.5.1 Ethernet ports

The CIU 888 has six dedicated Ethernet ports, as shown in FIGURE and FIGURE 1-7. The sixth port is located on the front panel.

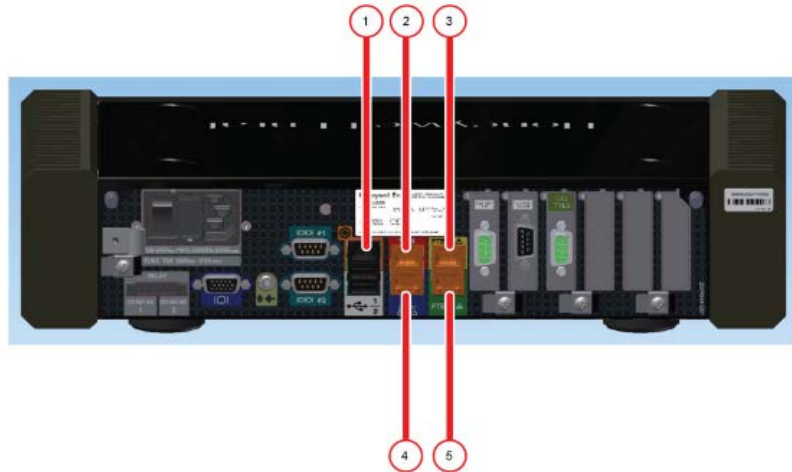

- |                   |                    |
|-------------------|--------------------|
| 1. Sync Link port | 4. Office LAN port |
| 2. VPN port       | 5. FTE port B      |
| 3. FTE port A     | 6. Service Port    |

---

## Introduction

---

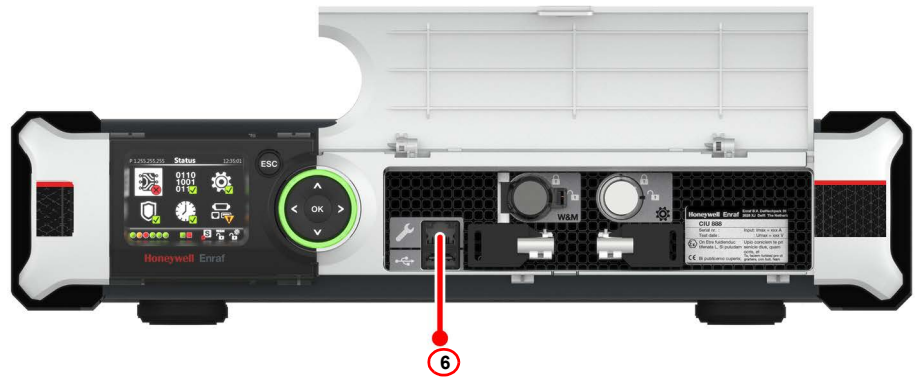

FIGURE 1-7

CIU 888: Service port on the front and back panel

---

---

## Introduction

---

TABLE 1-2 provides a description of each port.

TABLE 1-2 Description of the Ethernet ports

---

Ethernet port	Description
Service port	The Service port is used to set up a point-to-point connection between the CIU 888 and a service laptop/PC, allowing service technicians to configure the CIU 888 including field instruments connected to the CIU 888, and to perform system diagnostics. The Service port is also used to perform firmware upgrades and to view/update the license of the CIU 888. The service port is conveniently located at the front of CIU 888 for easy access.
Sync Link port	The Sync Link port is used as a dedicated, private synchronization link (point-to-point) between two CIU 888s in a redundant system setup. Continuous data synchronization between the CIUs guarantees highest data availability.
VPN port	The VPN port is intended to be used to set up a secure point-to-point connection to provide remote access enabling off-site service and diagnostics of CIU 888 and gauges. This port is enabled with configurable IP address for local servicing of CIU 888 and gauges. The remote access enabling off-site service and diagnostics of CIU 888, and gauges will be enabled in future releases.
FTE ports	The FTE (Fault Tolerant Ethernet) ports are intended to be used to set up individual connections between the CIU 888 and host systems such as PLCs and DCSs. The FTE ports can also be used combined to support an FTE connection with Experion. By providing multiple communication paths between nodes (servers and stations), FTE tolerates more faults, i.e., all single faults, as well as many multiple faults. FTE ensures a rapid response in case of communication failures with minimal switchover time. Ethernet nodes with no FTE hardware or software can be connected to the FTE control network and benefit from its highly available communications environment.
Office LAN port	The Office LAN port is intended to be used to connect the CIU 888 (and the control network it is part of) to the business network of the site in order to securely share data with office applications, thereby saving costs on operation and data exchange.

Network segregation is supported by the CIU 888 - a software-based firewall ensures that only the required socket ports are opened for each enabled Ethernet port. The firewall monitors and identifies all incoming and outgoing network traffic and blocks all unwanted network traffic.

### 1.5.2 Serial host ports

To support existing applications, the CIU 888 has two fixed serial (RS-232/RS-485) host ports, as shown in FIGURE 1-8.

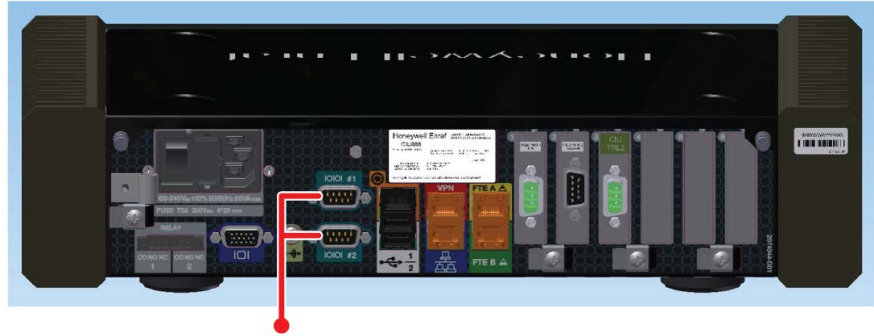

FIGURE 1-8 CIU 888: Fixed serial host ports

---

These serial ports can be used to connect hosts with the CIU 888 using modbus RTU. The 100% compatibility with the CIU 880 interface ensures a smooth migration of existing applications. Other modbus mapping is also possible to support other data to be transferred.

Alternatively, any host port can be configured to support the standard CIU 858 protocol and ensures to provide backward compatibility.

### 1.5.3 Ethernet host ports

CIU 888 supports ethernet connectivity to Tank Inventory systems via FTEA, FTEB and Office LAN ports as shown in FIGURE 1-9.

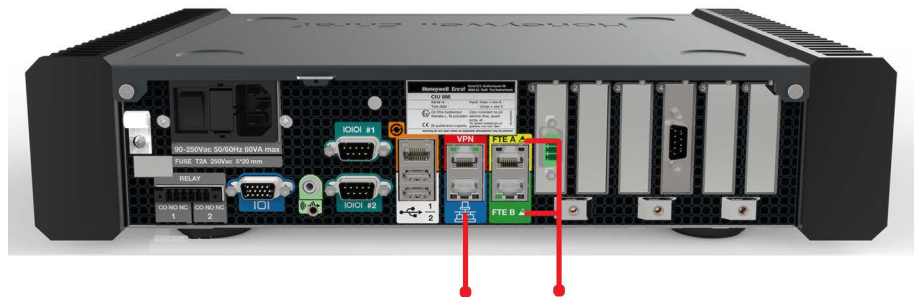

FIGURE 1-9 CIU 888: Ethernet host ports

---

These ethernet ports (FTEA, FTEB, Office LAN) can be used to connect hosts with the CIU 888 using Modbus TCP/IP and OPC UA TCP. Modbus maps supported by ethernet host ports are the same as that of serial host ports.



### 1.5.4 Option slots

The CIU 888 has six option slots, as shown in FIGURE 1-10.

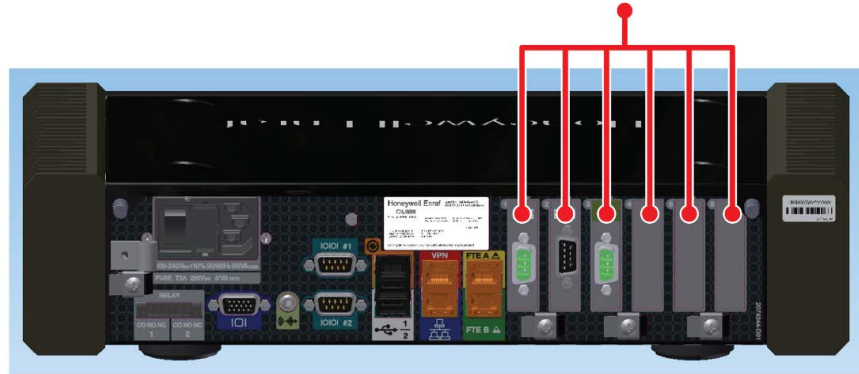

FIGURE 1-10

CIU 888: Option slots

The options slots support a wide range of connectivity possibilities, including:

- Gauging instruments on bulk storage tanks connecting over BPM or serial (RS-232/RS-485) field lines
- Gauging instruments on bulk storage tanks connecting over TRL/2 (Emerson Rex 2160)
- Host systems connecting over serial (RS-232/RS-485) field lines
- Downlink CIU (i.e., CIU 858, SmartLink) with gauges, connecting over serial (RS-232/RS-485) field lines
- Honeywell/third party Modbus field devices connecting over serial (RS-232/RS-485) field lines
- HART, Modbus or other protocol field devices connected to CIU 888 Via Modbus data concentrator and communicating over serial (RS-232/RS-485) field lines
- Honeywell/third party TRL/2 Modbus field devices connecting over TRL/2 field lines

### 1.5.5 USB ports

The CIU 888 has three USB ports as shown in FIGURE 1-11 and FIGURE 1-12. The USB ports enable connection of data storage devices, such as USB flash drives and pen drives, in order to install firmware upgrades and CIU 888 license updates.

*NOTE: See the Firmware Upgrade Manual CIU 888 (Part No. 4417596) for more information.*



FIGURE 1-11 CIU 888: USB port located at the front

---



FIGURE 1-12 CIU 888: USB ports located at the back

---

By default, access to the USB ports is disabled in order to prevent accidental infection or distribution of malware. The USB ports are enabled only when required for example, enabled during firmware upgrade and disabled after the operation is completed.

*NOTE: See the IT Security Manual CIU 888 (Part No. 4417597) for more information.*

### 1.5.6 Relays

The CIU 888 has two relays located at the back, as shown in FIGURE 1-13. Each relay has three contacts: CO (Common), NO (Normally open) and NC (Normally closed).



FIGURE 1-13

CIU 888: Relays

---

The relays are intended to be used in future for multiple purposes, for example to control systems like Distributed Control Systems (DCSs) via a hardwire connection and indicate system status.

### 1.5.7 Other connections

A VGA connector and an audio connection are located at the back of the CIU 888, as shown in FIGURE 1-14. Both are for future use.

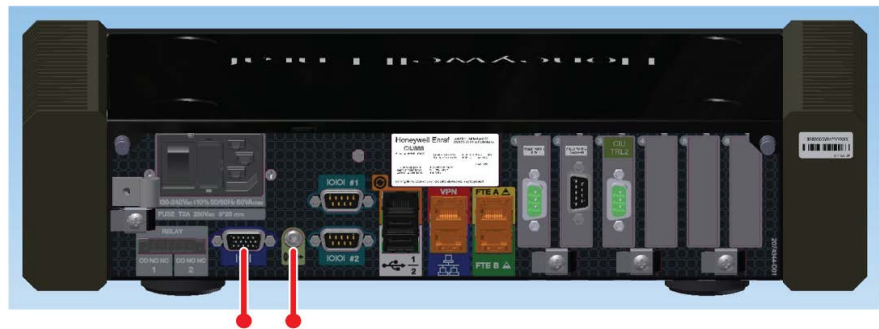

FIGURE 1-14

CIU 888: VGA connector and audio input

---

## 1.6 Up-to-date regulatory compliance

The CIU 888 is verified and approved by internationally recognized metrology authorities, to international accepted industry standards for the assessment of taxes or duties. Coverage can be expanded to support new or specific standards.

*NOTE: See the Sealing Guide CIU 888 (Part No. 4417595) for more information.*

### 1.7 Maximizing data availability through full redundancy

Operations for inventory control and custody transfer rely on accuracy, reliability and availability of the tank gauging system. By setting up two CIU 888s in a redundant system setup, system reliability and availability can be increased even more. Continuous data synchronization and host-initiated switchover ensures highest data availability and smooth transition between CIUs, with minimal interruption of critical applications and services.

### 1.8 Remote access for safe and secure support of gauges

CIU 888 is the interconnection between gauging instruments in the field and service tools, such as Honeywell's *Engauge and Rosemount TankMaster*, in the site control room. All Honeywell gauging instruments communicating via GPU/Flexconn protocol/TRL/2 can be accessed and configured remotely via the CIU 888 in a safe and secure way, enabling site support and more efficient commissioning. In a similar manner, the Emerson TRL/2 devices (e.g., Rex gauges) can also be accessed and configured remotely via CIU 888.

*This page is intentionally left blank*

**CHAPTER 2 TECHNICAL SPECIFICATIONS AND DIMENSIONS**

**2.1 Technical Specifications - Functional (Software version R140)**

General	
Description	Field scanning and communication interface for tank Inventory applications with optional embedded tank inventory calculation functionality.
Application	For all applications requiring accurate and reliable process and inventory data, such as refineries, tank farms and terminals. Data is suitable for custody transfer, safe product transfer and tank farm operation.
Intended Use	Control room equipment.
Legal Metrology and Custody Transfer	Compliant to API standards as stated by approval and certification by notified bodies as NMI.

Functional Specification	
Tank Database	80 tanks (tanks with one level gauge) 40 tanks (tanks with dual level gauge)
Redundancy	Hot standby and real-time synchronization.
	Switchover within 10 seconds.
Supported Gauge Models	All GPU enabled tank gauges (such as 811, 813, 865, 866, 854, 872, 873, 877, 894, 990 and 954)
Modbus Gauges	Smartline level transmitter (SLG 700) via Moore HCS Modbus HART converter
TRL/2 Gauges	Honeywell TRL/2 Radar gauge (990) (+ VITO) Rex RTG gauge (+ SDAU)
Gauge Commands	<ul style="list-style-type: none"> <li>- Lock Test</li> <li>- Freeze</li> <li>- Alarm Test (SmartRadar)</li> <li>- Unlock</li> <li>- Calibrate (854, 894, 990)</li> <li>- Water Dip</li> <li>- Block</li> <li>- Density Dip</li> <li>- Density profile</li> </ul>
Tank Scanning	Max. 6 field ports sequential and/or parallel.
Inventory Calculations	Conform API MPMS Ch. 12.1.
Tank Capacity Tables (Strapping Tables)	Up to 5,000 straps per tank. 400,000 straps total.

## Technical Specifications and Dimensions

Functional Specification			
Support API/ASTM Product Calculations	<ul style="list-style-type: none"> <li>- ASTM D1250-52 Table 23, 24, 53 and 54</li> <li>- ASTM D1250-1980; conform Vol. X - Tables, 5, 6, 23, 24, 53, 54, 59 and 60 and 59, 60 Alternative Temperature, product groups A, B, C, D</li> <li>- API MPMS Ch. 11.1 (2007; adj. to ASTM D1250-04 and IP-200) - Tables 5, 6, 23, 24, 53, 54, 59, 60 and 59, 60 Alternative Temperature, product groups A, B, C, D</li> <li>- API MPMS Ch. 11.2.4 (GPA TP-27) - Tables 23, 24, 53, 54, 59, 60 and 59, 60 Alternative Temperature, product group E</li> <li>- ASTM D4311-15</li> <li>- ASTM D4311M-15</li> <li>- ASTM D1555-16</li> <li>- ASTM D1555M-16</li> <li>- ASTM D4311-83 Table 1 and 2</li> <li>- ASTM D4311-96 Table 1</li> <li>- ASTM D4311-04 Table 1 and 2</li> <li>- ASTM D4311-15 (Asphalts and Bitumen)</li> <li>- ASTM D4311M-15 (Asphalts and Bitumen)</li> <li>- ASTM D1555-16 (Aromatic Hydrocarbons)</li> <li>- ASTM D1555M-16 (Aromatic Hydrocarbons)</li> </ul>		
Support Other Product Calculations	<ul style="list-style-type: none"> <li>- EN15940-19 (Hydrogenated Vegetable Oil)</li> <li>- SGS-21 (Ammonia)</li> <li>- NBR15639-16 (Ethanol / Alcohol)</li> <li>- User configurable density table</li> <li>- User configurable CTL table</li> <li>- User configurable concentration table</li> </ul>		
Available Gauge Data	<table style="width: 100%; border: none;"> <tr> <td style="border: none; vertical-align: top;"> <ul style="list-style-type: none"> <li>- Product Level</li> <li>- Product Temperature</li> <li>- Vapor Pressure</li> <li>- Water Level</li> <li>- Spot Temperatures</li> <li>- Floating roof levels</li> </ul> </td> <td style="border: none; vertical-align: top;"> <ul style="list-style-type: none"> <li>- Gauge Status and Alarms</li> <li>- Vapor Temperature</li> <li>- Ambient Temperature</li> <li>- Observed Density (Servo, HTG, HIMS)</li> <li>- Product Pressure</li> </ul> </td> </tr> </table>	<ul style="list-style-type: none"> <li>- Product Level</li> <li>- Product Temperature</li> <li>- Vapor Pressure</li> <li>- Water Level</li> <li>- Spot Temperatures</li> <li>- Floating roof levels</li> </ul>	<ul style="list-style-type: none"> <li>- Gauge Status and Alarms</li> <li>- Vapor Temperature</li> <li>- Ambient Temperature</li> <li>- Observed Density (Servo, HTG, HIMS)</li> <li>- Product Pressure</li> </ul>
<ul style="list-style-type: none"> <li>- Product Level</li> <li>- Product Temperature</li> <li>- Vapor Pressure</li> <li>- Water Level</li> <li>- Spot Temperatures</li> <li>- Floating roof levels</li> </ul>	<ul style="list-style-type: none"> <li>- Gauge Status and Alarms</li> <li>- Vapor Temperature</li> <li>- Ambient Temperature</li> <li>- Observed Density (Servo, HTG, HIMS)</li> <li>- Product Pressure</li> </ul>		
Available (Calculated) Inventory Data	<table style="width: 100%; border: none;"> <tr> <td style="border: none; vertical-align: top;"> <ul style="list-style-type: none"> <li>- S&amp;W, Vapor (4 types), DCF, TCF, manual CTL</li> <li>- Volume (TOV, GOV, GSV, NSV)</li> <li>- Reference Density</li> <li>- Weight (NSW, GSW)</li> </ul> </td> <td style="border: none; vertical-align: top;"> <ul style="list-style-type: none"> <li>- Mass (liquid, vapor, total)</li> <li>- Volume Correction Factor (VCF, CTL)</li> <li>- Volume Derived Flow</li> </ul> </td> </tr> </table>	<ul style="list-style-type: none"> <li>- S&amp;W, Vapor (4 types), DCF, TCF, manual CTL</li> <li>- Volume (TOV, GOV, GSV, NSV)</li> <li>- Reference Density</li> <li>- Weight (NSW, GSW)</li> </ul>	<ul style="list-style-type: none"> <li>- Mass (liquid, vapor, total)</li> <li>- Volume Correction Factor (VCF, CTL)</li> <li>- Volume Derived Flow</li> </ul>
<ul style="list-style-type: none"> <li>- S&amp;W, Vapor (4 types), DCF, TCF, manual CTL</li> <li>- Volume (TOV, GOV, GSV, NSV)</li> <li>- Reference Density</li> <li>- Weight (NSW, GSW)</li> </ul>	<ul style="list-style-type: none"> <li>- Mass (liquid, vapor, total)</li> <li>- Volume Correction Factor (VCF, CTL)</li> <li>- Volume Derived Flow</li> </ul>		
Clock & Time Synchronization	External using (optional) Entis Pro (or) ENTIS.		
Supported Engineering Units	- Level	m, mm, ft, in, in/16 and ft-in-16 (fis)	
	- Temperature	°C, °F	
	- Density	kg/m <sup>3</sup> , °API, lb/ft <sup>3</sup> , RD60, lb/USgal	
	- Pressure	kgf/cm <sup>2</sup> , kPa, psi(g), Pa	
	- Volume	m <sup>3</sup> , USgal, bbl, l(L)	
	- Mass/weight	kg, lb, metric ton, long ton, US ton	
	- Flow	m <sup>3</sup> /min, m <sup>3</sup> /h, l/min, l/h, bbl/min, bbl/h, USgal/min, USgal/h, UKgal/h	
	- Area	m <sup>2</sup> , mm <sup>2</sup> , ft <sup>2</sup> , in <sup>2</sup> , yd <sup>2</sup>	

## Technical Specifications and Dimensions

Functional Specification	
Available Correction Methods	<ul style="list-style-type: none"> <li>- CTSh</li> <li>- Floating Roof Weight</li> <li>- Temperature GRH</li> <li>- Pressure GRH</li> <li>- Servo Wire correction</li> <li>- Floating Roof Immersion Compensation (RIC)</li> </ul>
Native profiles support	<ul style="list-style-type: none"> <li>- Temperature profiles data - Periodic scanning of temperature profiles data from BPM and TRL/2 gauges and presentation in Modbus output (RTU and TCP/IP) and OPC UA TCP output based on configuration.</li> <li>- Density profiles data - Density profiles data collection up to 50 density points from Honeywell Servo gauges and presentation in Modbus output (RTU and TCP/IP) and OPC UA TCP output based on user command.</li> </ul>
Host Connectivity	
Serial Ports	2x Modbus serial + 4 additional ports by using option slots
Ethernet Ports	3x Modbus TCP/IP and / or OPC UA TCP ethernet (FTEA, FTEB and Office LAN)
Supported Host Protocols	<ul style="list-style-type: none"> <li>- Serial Modbus Server (CIU 880 Modbus maps and CIU 888 Modbus maps)</li> <li>- Ethernet Modbus TCP/IP Server (CIU 880 Modbus maps and CIU 888 Modbus maps)</li> <li>- CIU 858 Emulation</li> <li>- Modbus Emulation</li> <li>- OPC UA TCP Server</li> </ul>
Number of Modbus TCP/IP Clients	15
Number of OPC UA TCP Clients	10
Field Connectivity	
Field Ports	6x option slots (of which 4 Serial ports can be used for host connectivity).
Wireless Connectivity	ISA 100 via Honeywell WDM 80 wireless devices supported
Available Option Boards	<ul style="list-style-type: none"> <li>- Enraf Serial Communication Card</li> <li>- Enraf TRL/2 Field Bus Card</li> <li>- Serial Modbus Card</li> </ul>
Compliance & Certifications	
European Directives	<ul style="list-style-type: none"> <li>- CE</li> <li>- 2014/35/EU (Low Voltage directive)</li> <li>- 2014/30/EU (EMC)</li> </ul>
US & Canada Regulations	<ul style="list-style-type: none"> <li>- FCC Title 47 CFR 15 Subpart B</li> <li>- CSA CAN/CSA-C22.2 NO. 61010-1-12 AMD 1</li> <li>- UL 61010-1 (3rd Edition) AMD1: 2016 Revision through 2019</li> </ul>
IT Security	Conform WIB M 2784-X - 10
User Interface	Designed for compliance with NAMUR NE 43
Self-Monitoring & Diagnostics	Designed for compliance with NAMUR NE 107



## Technical Specifications and Dimensions

### Compliance & Certifications

Legal Metrology (Weights & Measures)	<ul style="list-style-type: none"> <li>- NMI - Netherlands</li> <li>- OIML - Global</li> <li>- PTB - Germany</li> </ul>
--------------------------------------	---

## 2.2 CIU 888 Option Board Specifications

### Enraf BPM Field Bus Card

Physical Layer	2-wire Bi-phase mark modulated (MIL-STD-1553)
Supported Protocol(s)	Enraf BPM
Typical No. Field Devices	10-15, depending on cable specifications and length
Baud Rate	1200/2400/4800 Baud
Distance	10 km or more depending on cable characteristics
Cable Characteristics	1 uF/200 Ohm max.
Type of Galvanic Isolation	Transformer coupled with ground shield
Galvanic Isolation	1500 V

### Enraf Serial Communication Card

Physical Layer	2/4-wire RS-485 or RS-232C
Protocol(s)	GPU/Flexconn Client (for field communications) Modbus Client (for field communications)
Baud Rate	1200 up to 38400 Baud
Type of Galvanic Isolation	Opto isolation
Galvanic Isolation	1500 V

### Serial Modbus Card

Physical Layer	2/4-wire RS-485 or RS-232C
Protocol(s)	Modbus - Server (for host communication)
Baud Rate	1200 up to 38400 Baud
Type of Galvanic Isolation	Opto isolation
Galvanic Isolation	1500 V

### Enraf TRL/2 Field Bus Card

Physical Layer	Emerson TRL/2 Protocol
Supported Protocol(s)	Modbus RTU
Typical No. Field Devices	8
Baud Rate	4800 Baud
Distance	4 km
Cable Characteristics	18 AWG (minimum) with shielded twisted pair, max 4 kms with max 8 multi drop Gauge connections
Type of Galvanic Isolation	Transformer coupled with ground shield

## Technical Specifications and Dimensions

Enraf TRL/2 Field Bus Card	
Galvanic Isolation	1500 V

### 2.3 Technical Specifications - Hardware

Electrical	
Power Supply	100-240 Vac, auto ranging (-10% to +10%), 45-65 Hz
Power Rating	Max. 60 VA (35 VA nominal)
Nominal Start-Up Current	60 mA (Fuse: 2A Slow Blow) Start Up Current is (inrush): 60A @230V
Overall Voltage Category	II
Cooling System	2 heat sinks with heat pipe design (no moving parts)
Battery	Type 3V, 225mAh, 23mm (for back-up system clock only - 10 years estimated service time)

Operating System	
O/S	Arch Linux
Memory	4 GB Flash memory (upgradable)

User Interface and I/O	
Front Panel Display	Backlight LCD color display (50 x 38 mm; 320 x 240 pixels) for status and diagnostics
User Input	6 switches (←, →, ↑, ↓, OK and Esc) with LED (ring of light) status indication
Key Lock Switches	2x (for configuration and LM sealing respectively)
Relay Output	2x DPDT for CIU status (Hot Standby); contact rating: 30VDC, 1A
Video Output	SVGA (future use)
Audio Output	1x std. line out (x Vtt), 3.5 mm mini jack
Serial Ports	2x basic isolation
Ethernet Ports	5x 10/100 Mb on back side
Service Ethernet Port	1x behind front panel - DHCP enabled, auto sensing, 10/100 Mb
USB Ports	1x behind front panel; 2x on back side - default disabled

Environmental	
Ambient Temperature	0 °C to +60 °C (+32 °F to +140 °F)
Storage Temperature	-20 °C to +85 °C (-40 °F to +185 °F)
Enclosure Classification	IP 40 (NEMA 1)*
Humidity	0% to 90% non-condensing
Altitude	Up to 2000 meters
EMC Class	CLASS A

---

## Technical Specifications and Dimensions

---

\* Evaluated by Honeywell.

<b>Mechanical</b>	
Materials	<ul style="list-style-type: none"><li>- Enclosure: Acryl painted steel</li><li>- Heat sinks (left and right side): Black anodized aluminum</li><li>- Front panel: ABS/PPE</li></ul>
Dimensions	400 x 93 x 283 mm (WxHxD) (15¾ x 3¾ x 11¼ in. (WxHxD))
Weight	~ 6 kg (13.2 lb)
Installation	Wall mounting, 19" rack or table top
Max. Load on Top (Table Top Use)	10 kg (22.0 lb)

2.4 Dimensional drawing

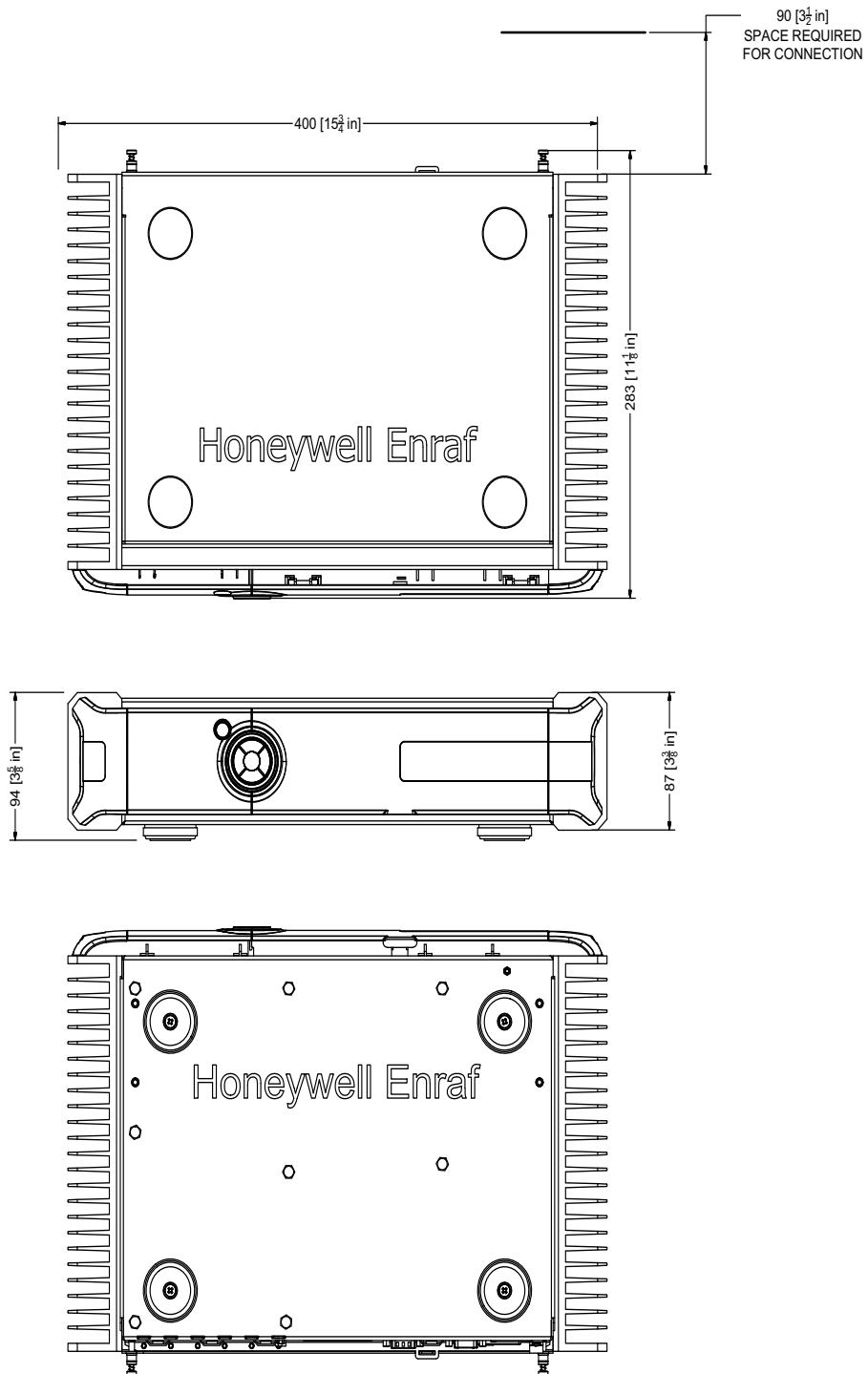

FIGURE 2-15

Overall dimensions of the CIU 888

---

---

## APPENDIX A LIST OF ABBREVIATIONS

---

Abbreviation	Meaning
API	American Petroleum Institute
ASTM	American Society for Testing and Materials
BPM	Bi-Phase Mark
CRC	Cyclic Redundancy Check
CTL	Correction for Temperature on Liquid
DCS	Distributed Control Systems
FTE	Fault Tolerant Ethernet
GOV	Gross Observed Volume
GPU	Gauge Processing Unit
GSV	Gross Standard Volume
IT	Information Technology
LAN	Local Area Network
NMi	Netherlands Measurement Institute (Nederlands Meetinstituut)
NSV	Net Standard Volume
OIML	International Organization of Legal Metrology (French: <i>Organisation Internationale de Métrologie Légale</i> )
PC	Personal Computer
PLC	Programmable Logic Controller
RS	Recommend Standard
RTU	Remote Terminal Unit
TOV	Total Observed Volume
TRL	Tank Radar Level
USB	Universal Serial Bus
VCF	Volume Correction Factor
VGA	Video Graphics Array
VPN	Virtual Private Network
W&M	Weights and Measures
LM	Legal Metrology

---

---

*This page is intentionally left blank.*

For service-related questions, contact:

**Technical Assistance Centre**

Phone:

+1 800 423 9883 or

+1 215 641 3610

E-mail:

[HFS-TAC-SUPPORT@honeywell.com](mailto:HFS-TAC-SUPPORT@honeywell.com)

---

**Copyright © 2022 - Honeywell**

All rights reserved. No part of this manual may be reproduced in any form, by print, photoprint, microfilm or any other means without the written permission from Honeywell.

## **For More Information**

To learn more about Honeywell Enraf's solutions, contact your Honeywell Enraf account manager or visit [www.honeywellenraf.com](http://www.honeywellenraf.com).

### **Americas**

Honeywell Enraf Americas, Inc.  
1250 West Sam Houston Pkwy S.  
Houston, TX 77042  
USA  
Phone: +1 (480) 293-2042  
Email: [enraf-us@honeywell.com](mailto:enraf-us@honeywell.com)

### **Asia Pacific**

Honeywell Pte Ltd.  
17 Changi Business Park Central 1  
Singapore 486073  
Phone: +65 6355 2828  
Email: [enraf-sg@honeywell.com](mailto:enraf-sg@honeywell.com)

### **Europe, Middle East and Africa**

Honeywell Enraf  
Delftechpark 39  
2628 XJ Delft the Netherlands  
Phone: +31 (0)15 2701 100  
Email: [enraf-nl@honeywell.com](mailto:enraf-nl@honeywell.com)

4417591\_Rev15  
December 2022  
© 2022 Honeywell.

The Honeywell logo is displayed in a bold, red, sans-serif font.