

CUP-BB5
HEAVY DUTY, RADially SPLIT,
MULTI-STAGE PUMPS

CLYDEUNION®
PUMP

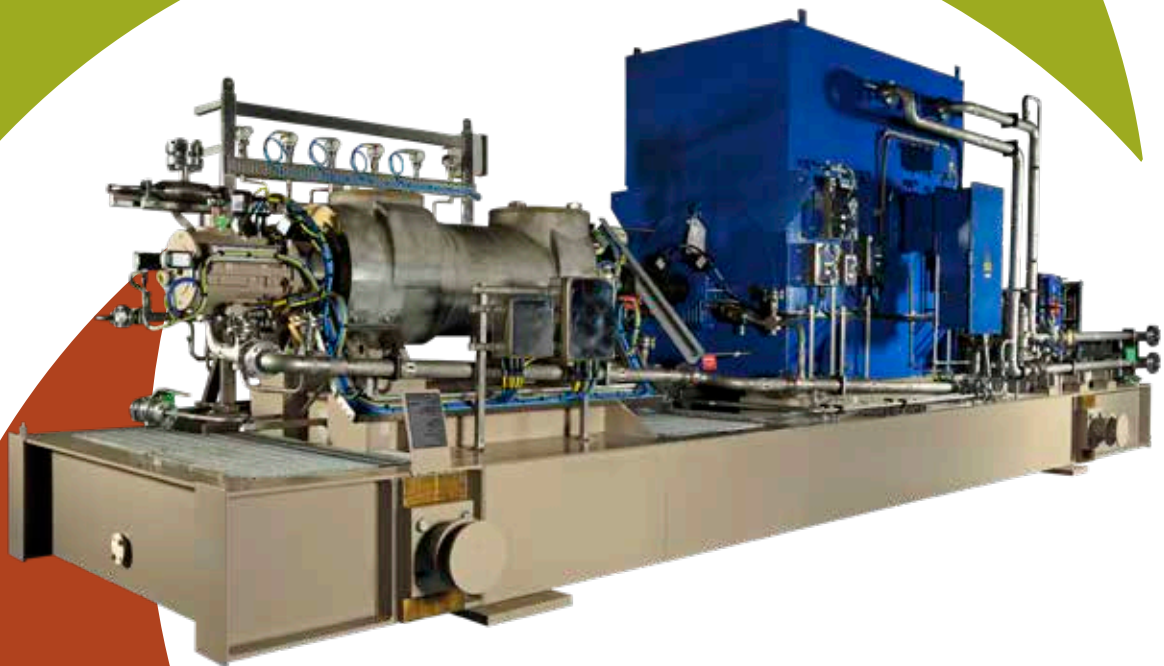

CLYDEUNION PUMPS – AN INTRODUCTION

ClydeUnion Pumps is the culmination of a long and eventful 140-year engineering legacy. In fact, most nuclear power plants currently in operation around the world employ our reactor feed pumps. We play an instrumental role in securing the vital energy and water resources that a sustainable society will rely on in the future.

Not only servicing the Nuclear market we are also a valued flow control engineering partner to the oil/gas industry – supporting upstream, downstream, transportation and offshore

exploration activities. Other key areas we address include seawater desalination, waste water treatment, mining and steel production.

Combining a wealth of pump and system design knowledge, latest design, analytical and pump testing equipment, we are confident we can boost efficiency and ensure prolonged operation of our products.

COMMITMENT TO QUALITY

At Celeros FT, you will find a commitment to quality throughout the company. Our Quality Management System is fully approved to ISO 9001:2008 and independently verified to comply with the latest quality standards. Our ClydeUnion Pumps brand has a worldwide reputation for providing optimised reliability, with our API 610 centrifugal pumps and pumping packages, in the most severe duty applications.

Celeros FT is an environmentally responsible company. In recognition of efforts considering the environment and surroundings, our Glasgow facility has been awarded the ISO 14000:2004 series of international standards.

Celeros FT also understands the challenges faced in acquiring and maintaining the high standards required to design and build nuclear coded pumps, and the company has three coded facilities with a long history of excellence.

OIL & GAS EXPLORATION & PRODUCTION

High efficiency and reliability are major benefits of ClydeUnion Pumps equipment – both of which are vital considerations in the oil and gas industry. Our ClydeUnion Pumps brand has a reputation for providing engineered pumping solutions for some of the most arduous applications, in the most hostile environmental conditions imaginable. Our pumps are supplied to satisfy a wide range of pumping services including produced water injection, seawater injection, crude oil transfer, main oil lines, as well as pumps for handling all types of industry related fluids.

Typical applications

- Refineries
- Gas plants
- Oil production facilities
- Pipelines
- Seawater injection
- Boiler feed water
- Hydrocarbon
- Produced water injection
- Flowline displacement
- Main oil lines

REFINERIES

Today's complex refinery processes demand specialised pumping solutions. Extremes of temperature, high-pressure and the ability to handle volatile fluids, calls for highly engineered pumps that can perform reliably in such arduous conditions. With many years of worldwide experience in supplying ClydeUnion process pumps to the refinery industry we are committed to providing our customers with solutions for the most complex of pumping requirements. Celeros Flow Technology has supplied ClydeUnion Pumps boiler feed pumps, safety related pumps and auxiliary pumps for a wide range of power generation plants over many years. The experience gained in this field enables us to offer our customers engineered products, tailored to their specific requirements.

POWER

ClydeUnion boiler feed pumps, safety related pumps and auxiliary pumps have been supplied for a wide range of power generation plants over many years.

The experience gained in this field enables us to offer our customers engineered products, tailored to their specific requirements.

PETROCHEMICALS

The process and transferring of petrochemicals demands a high level of pumping reliability, and the ClydeUnion Pumps brand has a reputation for supplying reliable pumps which can be found working throughout the world in the most aggressive applications.





CUP-BB5 - HEAVY DUTY, RADIALY SPLIT, MULTI-STAGE PUMPS

PUMP OVERVIEW

The ClydeUnion Pumps CUP-BB5 range encompasses radially split, volute and diffuser type, multi-stage pumps specifically designed for the high pressure, high temperature and high speed service needs of the market.

We pride ourselves on our collaborative approach with our customers and suppliers to ensure the optimum engineered solution is achieved.

PROVEN PRODUCT INTEGRITY

The CUP-BB5 encompasses proven design history, evolving from our legacy Weir Pumps 'OK', Guinard 'HMBS' and David Brown 'DB36' machines. All contribute to an enviable heritage of sound engineering and are designed to exceed the rigorous requirements of API 610. CUP-BB5 pumps are among the most robust in the industry with superior design features providing long and trouble free operation for the thousands of multistage pumps operating worldwide, both onshore and offshore.

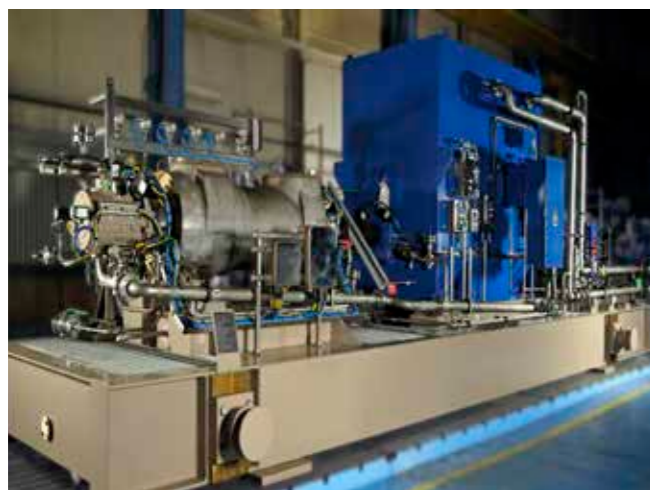

ENGINEERING EXCELLENCE

Due to these extensive heritage designs, there are several options available to meet your exact requirements.

Main constructions:

- Inline Diffuser** – Base offer, lowest cost design
- Back to Back Diffuser** – For increased stage counts
- Back to Back Volute** – For volute specific applications

Additional Features:

- All designs offered with a variety of end cover sealing arrangements
- Standard bolted arrangement up to our unique and industry leading shear ring design
- Two main variants of in-line impellers (CUP-BB5HPi) or back-to-back impeller arrangement (CUP-BB5HPb,)
- Bespoke units, engineered-to-order solutions
- Fully compliant with the latest API 610 and API 682 requirements and customer specifications
- maximum sustainable hydraulic efficiency, extended mean time between overhauls and reliability in operation.
- High critical speed margins and low static deflections reduce internal wear and increase reliability

There are hundreds of ClydeUnion Pumps CUP-BB5 units operating worldwide on services as diverse as:

- Hot hydrocarbon refinery services with temperatures in excess of 425°C (800° F)
- High suction pressure applications up to 100 Bar (1,450 psi) as standard with 300 Bar (4,350 psi) discharge capability
- Ethylene, propylene, LPG and all gas stripping products such as amine and lean solution These highly successful machines are used extensively throughout the oil & gas and power sectors.

RESEARCH & DEVELOPMENT

Celeros FT recognises the importance of continually advancing our ClydeUnion Pump product offering to meet the requirements of new technical challenges associated with ever deeper waters and remote locations.

Through our culture of innovation and a customer-centric approach we have positioned ourselves at the leading edge of pump design. Our efforts are focused on continuously improving and developing our technology, to ensure we deliver the most reliable, efficient, and low life-cycle cost products.

Beyond our CUP-BB5HP advancements, our CUP-BB5UHP has been specifically designed to address the requirements of ultra-high pressure injection duties, pushing the boundaries of pumping technology.

EASE OF MAINTENANCE

The simple construction of the CUP-BB5 pump offers ease of maintenance and reliability. The rotating element is housed within a horizontal, axially split inner case, subsequently contained in an outer barrel

case. This can be easily removed without disturbance to main pipework. A complete rotor change-out can be completed in under eight hours. To further reduce overhaul time we can provide spare cartridges offering like for like performance or re-rates.

RESEARCH & DEVELOPMENT

Celeros Flow Technology recognises the importance of continually advancing our product offering to meet the requirements of new technical challenges associated with ever deeper waters and remote locations.

Through our culture of innovation and a customer-centric approach we have positioned ourselves at the leading edge of pump design. Our efforts are focused on continuously improving and developing our technology, to ensure we deliver the most reliable, efficient, and low life-cycle cost products.

PUMPSETS & PACKAGES

Our wide-ranging experience extends to incorporating ClydeUnion CUP-BB5 pumps onto complex Pumpsets that include electric motors, gearboxes, lube oil systems, steam turbines, diesel engines, control panels and instrumentation.

OPERATING PARAMETERS:

CUP-BB5

- Capacities – up to 2,800 m³/hr / 12,330 USgpm
- Delivery Heads – up to 4,100 m / 13,450 ft
- Speeds – up to 6,600 rpm
- Flange drilling: ANSI or BS



CUP-BB5 - FEATURES

- 1 HEAVY DUTY PUMP CASING**
 - All flanges designed and rated for full maximum allowable working pressure and 2 x API 610 nozzle loads
 - Studded integral main flange connections top-top orientation as standard. Other types available
 - Foot or centre-line mounted
- 2 HIGH ROTOR STABILITY**
 - Optimal shaft-to-impeller diameter and bearing span proportions
 - Ensures high reliability, higher speeds, longer wear life and low static deflection
- 3 EASE OF MAINTENANCE**
 - Cartridge design can be removed from barrel casing as a complete unit
 - ClydeUnion Pumps Shear Ring locking system ensures rapid change-out and minimises pump downtime
- 4 PUMP HEALTHCARE MONITORING**
 - Temperature and vibration monitoring of critical components as standard
 - Wired to skid edge junction box or control panel
- 5 PRECISION CAST IMPELLERS**
 - Statically and dynamically balanced
 - Staggered to ensure optimum vibration performance to API 610 requirements
 - Shrink-fitted to shaft and individually radially located
- 6 BEARING HOUSINGS**
 - 360° mounting for optimum rotor support and low vibration levels
 - INPRO™ oil seals fitted as standard
 - Lift off design to facilitate ease of access to mechanical seals and bearings
- 7 ADVANCED MECHANICAL SEALING (TO API 682)**
 - Cartridge style (single or dual) mechanical seals as standard, with no external seal setting
 - API 682 seal chamber ensures maximum seal life and full seal interchangeability
- 8 ADVANCED METALLURGY**
 - Super Duplex alloys and high velocity oxygen flame overlays ensure long component life. Solid sintered tungsten carbide option for produced water applications
 - NACE and NORSOK certified when required

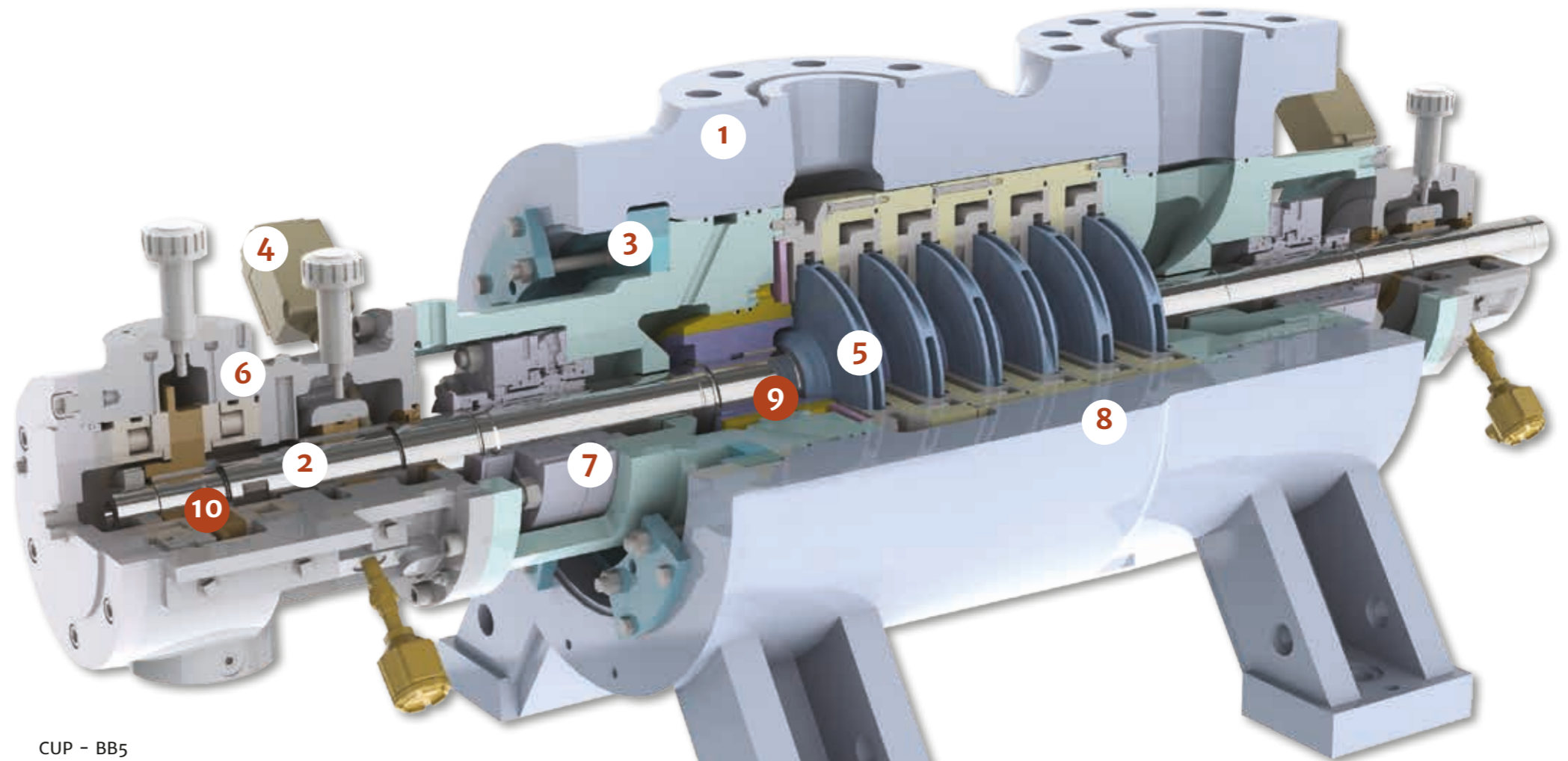

CUP - BB5
(in-line impeller arrangement)

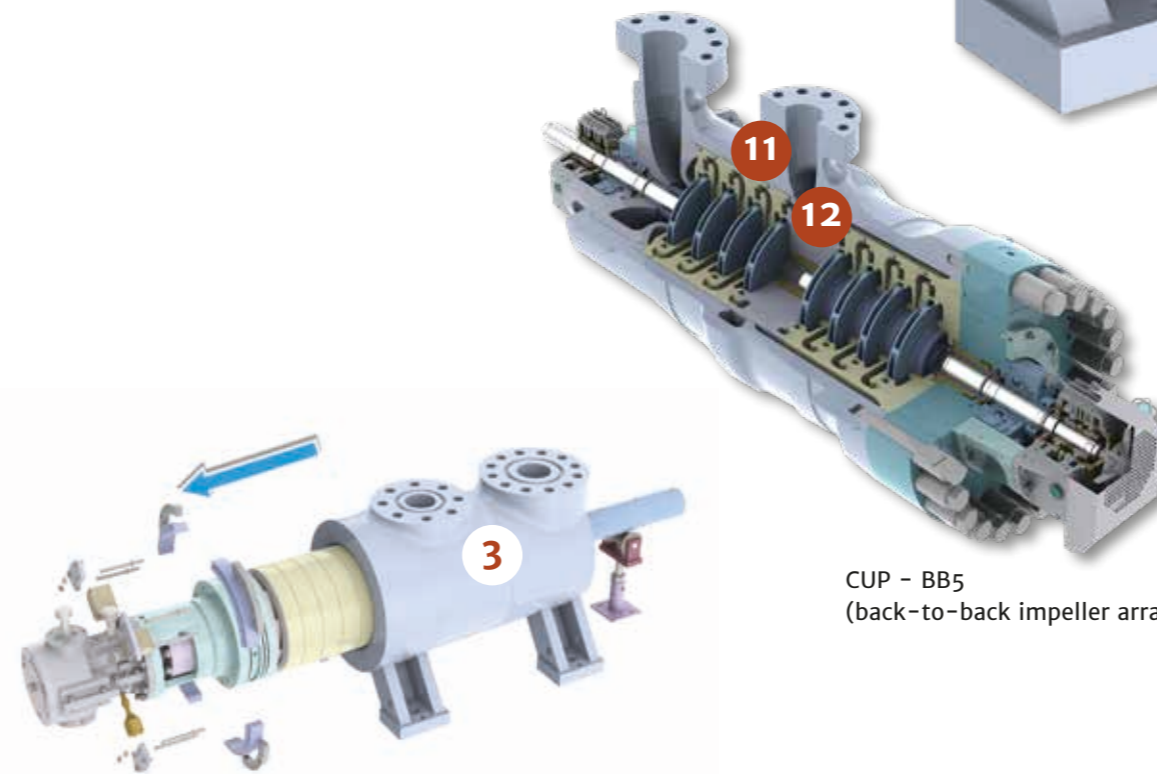

CUP - BB5
(back-to-back impeller arrangement)

- 9 HYDRAULIC BALANCING DEVICE**
 - Drum and bush arrangement to balance hydraulically generated thrust loads
- 10 BEARINGS**
 - Generously rated hydrodynamic double acting tilting pad (thrust) bearing
 - White metal lined hydrodynamic sleeve (journal) bearings
 - Hydrodynamic bearings have force fed lubrication as standard
 - Ball or Sleeve / Ball bearing options available
- 11 BACK-TO-BACK IMPELLER ARRANGEMENT**
 - Ensures hydraulic balancing of axial thrusts and eliminates the need for full pressure breakdown devices
 - Allows use of self-contained bearing on high stage counts
- 12 LABYRINTH CENTRE PIECE**
 - Smoothly transfers pumped fluid under differential pressure between the two banks of opposing impellers
 - The centre bush and sleeve ensure a supplementary stiffness to the shaft, aiding rotor stability and low vibration levels

CUP-BB5V FEATURES

- 1 BEARING ASSEMBLY**
 - 360° mounting gives class leading vibration levels
 - High capacity fan as standard
 - Flinger design improves lubrication and prevents 'black oil'
 - Pure or purge mist options
- 2 SEAL CHAMBER**
 - API 682 compliant
 - Space for dual seals
 - Easy access for maintenance
 - Locking collar arrangement as standard
- 3 SINGLE PIECE THROTTLE BUSHING**
 - Designed for pressure breakdown
 - Sized to balance axial thrust
- 4 CASE WEAR RING & BUSHES**
 - Positive location
 - Pinned for anti-rotation at split line
- 5 DOUBLE VOLUTE DESIGN**
 - Minimises radial thrust loads for optimised bearing and seal life
- 6 AXIALLY SPLIT INNER CASE**
 - Hydraulic re-rates available within existing casing
 - Minimises rotor change-out time (once removed from barrel)
- 7 INTEGRAL WEAR RINGS**
 - Reduced risk of failure due to wear part displacement
 - Retrofit with conventional rings when necessary
 - Conventional options available
- 8 SPLIT CENTRE BUSHING**
 - Facilitates inspection, removal and replacement
 - Maximises rotor support and dampening
- 9 INTEGRAL BALANCE LINE**
 - Equalises pressure in seal chambers
- 10 INTEGRALLY FLANGED AUXILIARY CONNECTIONS**
 - Eliminates weld connection
 - Eliminates need for bracing
 - Conventional options available

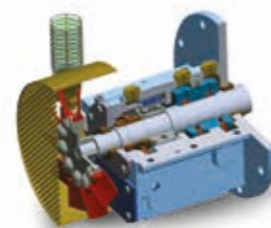
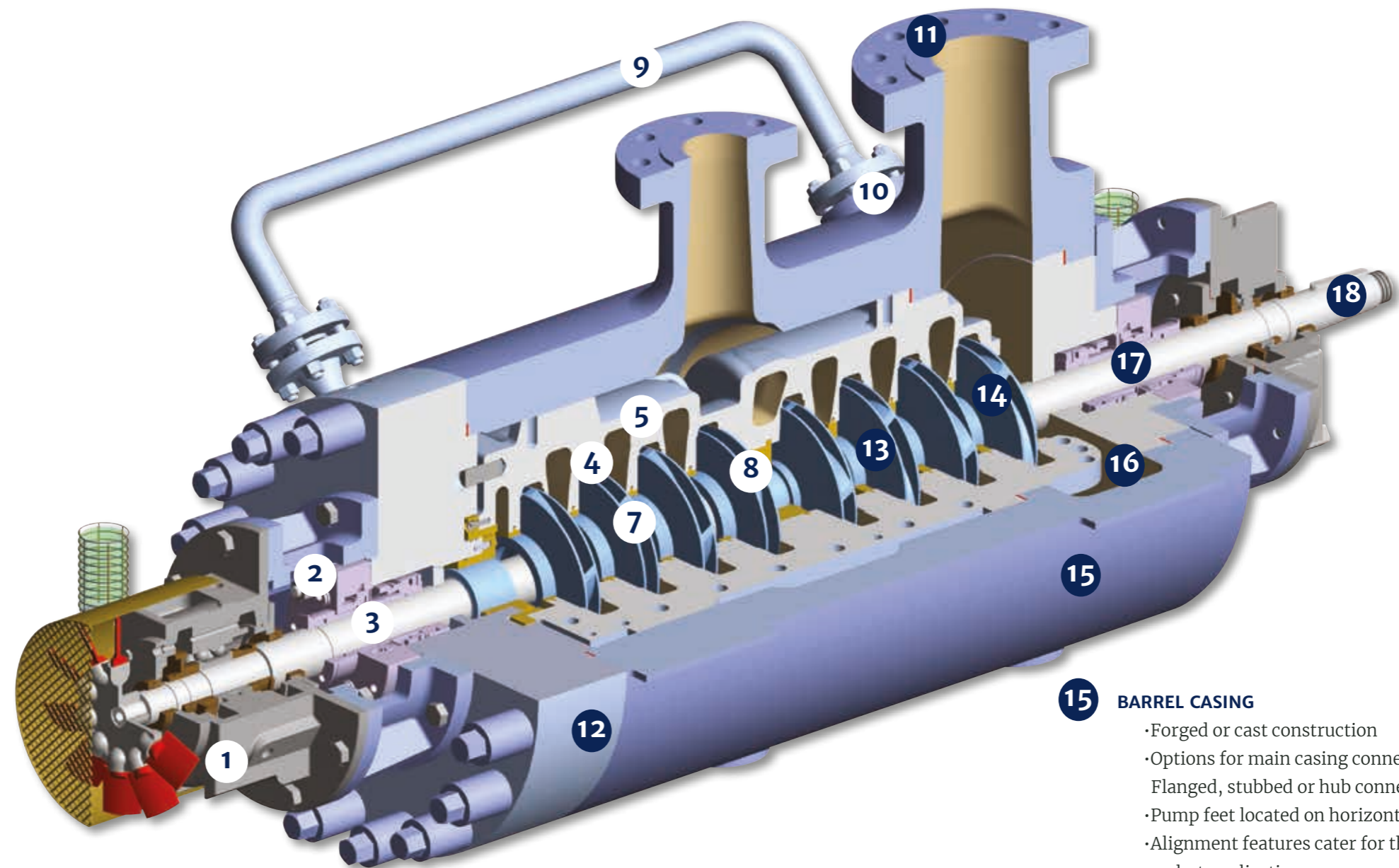

Standard ball/ball bearing assembly

- Designed for minimum 25,000

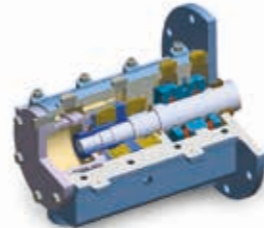

Optional sleeve/tilting pad bearing assembly

- High speed pumps up to 6,300 rpm
- High power pumps up to 3.80 MW

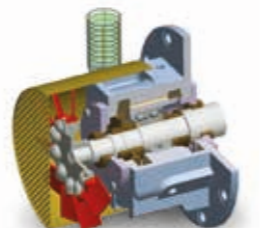

Optional sleeve/ball bearing assembly

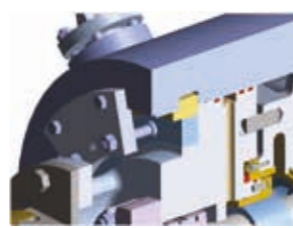

Shear ring design

- Suitable for both bolted and shear ring end cover designs (shear rings not relevant on BB5V design)

- 11 FLANGE FINISHES & RATINGS**
 - Heavy duty class 900 as standard
 - Higher pressure options available
 - Raised face and ring type joint options available
- 12 END COVER DESIGN**
 - Integral mechanical seal chamber complying to API 610 and API 682
 - Suited to high temperature applications
 - Bolted and shear ring options
- 13 IMPELLERS**
 - Back-to-back design to minimise axial thrust
 - Individually secured
 - Precision cast
- 14 OPTIMUM NPSH PERFORMANCE**
 - Option for double suction impeller

- 15 BARREL CASING**
 - Forged or cast construction
 - Options for main casing connections: Flanged, stubbed or hub connectors
 - Pump feet located on horizontal centreline
 - Alignment features cater for thermal expansion on hot applications
 - Main nozzle orientation to suit customer requirements
- 16 LIGHTWEIGHT SUCTION END COVER**
 - Offers effective sealing whilst eliminating heavy bolting
 - Integral mechanical seal chamber complying to API 610 and API 682
- 17 ROBUST ROTOR DESIGN**
 - Stepped shaft for ease of assembly
 - Optimised rotor dynamics and power transmission capability
- 18 API SHAFT TAPER**
 - For easy coupling removal
- 19 MATERIAL OPTIONS**
 - All API 610 material options
 - Other material options available
 - NACE compatible
 - Non-metallic wear parts

CUP-BB5V FEATURES

1 DRIVER OPTIONS

The CUP-BB5 can be packaged with various types of drive equipment to suit the application's needs.

Typical options include:

- Electric motors (fixed or variable speed)
- Combustion engines
- Gas or steam turbines

Further drive train options are available in order to achieve the optimal running speed:

- api 677 or api 613 gearbox units
- Fluid couplings (geared and/or variable speed)

2 COUPLINGS

- Flexible element membrane couplings as standard for high torque drives (to API 671 when required)
- Excellent angular, lateral and axial flexibility with low levels of imposed forces on equipment

3 LUBRICATION SYSTEMS

- Forced lubrication systems, for use with hydrodynamic bearings. To API 610 as a minimum, with API 614 options available
- For anti-friction bearing arrangements self-contained lubrication arrangements are commonly used

4 ANTI-VIBRATION MOUNTS (AVMS)

- Designed to reduce the transmission of vibration from machinery to the deck or ground
- 3 or 4 point mounting configurations available

5 ADVANCED SEALING ARRANGEMENTS (TO API 682)

Typically for non-sour service API 682 piping plans 11 and 31 utilise the process fluid as a flush within a single seal configuration.

For more robust solutions multiple seal arrangements are adopted. The options here are varied but fall into two principal categories:

• Unpressurised tandem arrangements

Typically API 682 piping plan 52

• Pressurised double arrangements

Typically API 682 secondary flush plans 53A/B/C, incorporating a variety of vessel-type reservoir sealant systems

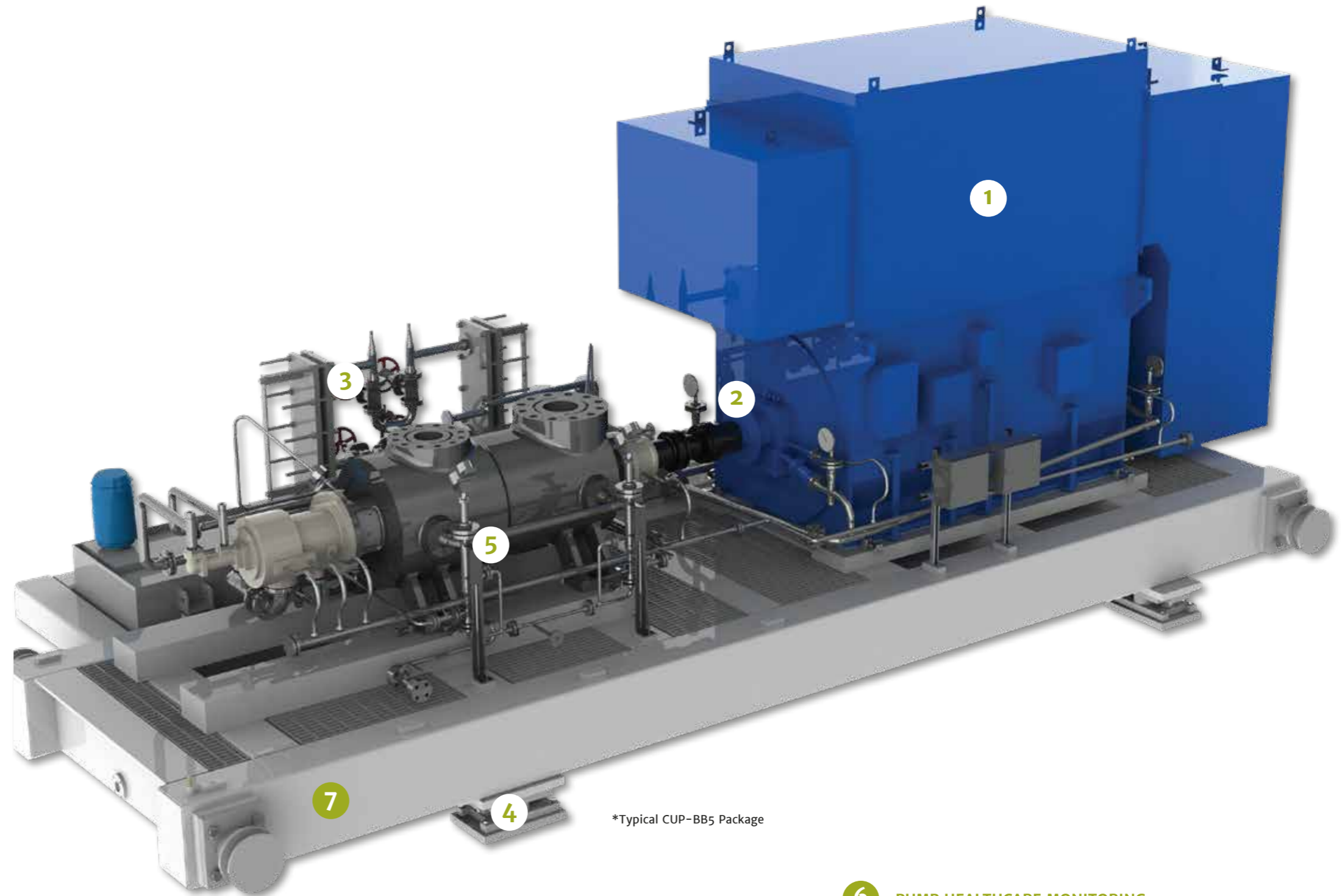

*Typical CUP-BB5 Package



6 PUMP HEALTHCARE MONITORING

Supplied with a range of monitoring equipment to enable measurement and analysis of performance data in order to aid preventative maintenance and increase availability. Systems designed in compliance with API 670 include:

- Instrumentation to continuously measure the equipment temperature, vibration, and pressure levels
- Controls to regulate the system operation

7 BASEPLATE DESIGN

- Static and dynamic analysis of the baseplate performed to ensure optimum structural integrity
- Designs influenced by factors including; customer specifications, equipment setup, and conditions prevailing at site
- Baseplates are all welded fabrications constructed from high quality rolled steel sections

OPTIONAL ARRANGEMENTS & FEATURES

IMPELLER OPTIONS

- Low NPSHr single entry first stage as standard
- Double entry first stage available
- Reliable performance and long impeller life
- Proven and optimised inlet design criteria assures cavitation free operation
- Designs are optimised by Computational Fluid Dynamics
- Cavitation visualisation rig testing capability
- Routinely NPSH tested

HYDRODYNAMIC BEARINGS

- Hydrodynamic double-acting thrust bearing used in conjunction with balance drum
- White metal lined hydrodynamic journal bearing
- Capable of higher load, higher speed operation
- Force-fed or self-contained options available
- Unlimited life dependent on oil cleanliness
- Optimum rotor stability
- Proven reliability in the most demanding service conditions

ROLLING ELEMENT BEARINGS

- Available depending on hydraulic balance arrangement and absorbed power
- Oil ring lubricated
- Self contained lubrication removes need for force-fed system
- Lower cost than hydrodynamic bearing, plus support system
- Rated for full radial and residual thrust load
- INPRO™ bearing isolators throughout give reduced contamination for improved sealing and bearing life

SHEAR RING DESIGN

- The CUP-BB5 incorporates our pioneering 'Shear Ring' cartridge locking system
- Applicable at temperatures up to 1200C this system reduces cartridge change-out time by 70% compared to the conventional bolted end cover alternatives
- Weight reduction of pump cartridge compared to heavy bolted end cover design
- Lighter maintenance lifts
- Eliminates need for heavy duty bolt tensioning equipment

WEAR PARTS

- Static, renewable wear parts, fitted to the casing are of solid one piece construction
- Impellers supplied with integral wear surface as standard. Option for renewable wear rings
- Materials selected for hardness differential and low galling properties
- Hard coatings (such as Tungsten Carbide) may be employed depending on service conditions and base material
- Solid sintered Tungsten Carbide used for extreme erosive conditions

FLEXIBLE OPERATION - DE-STAGING

- Cartridge can be supplied initially with 'spacer' stages to enable future uprating with the addition of impellers

CP SEAL SYSTEM OPTION

- Our patented CP System technology offers proven history in improving seal life, particularly under varying suction pressures

STANDARD HYDRAULIC RANGE - COVERAGE CHARTS

50HZ RANGE COVERAGE CHART

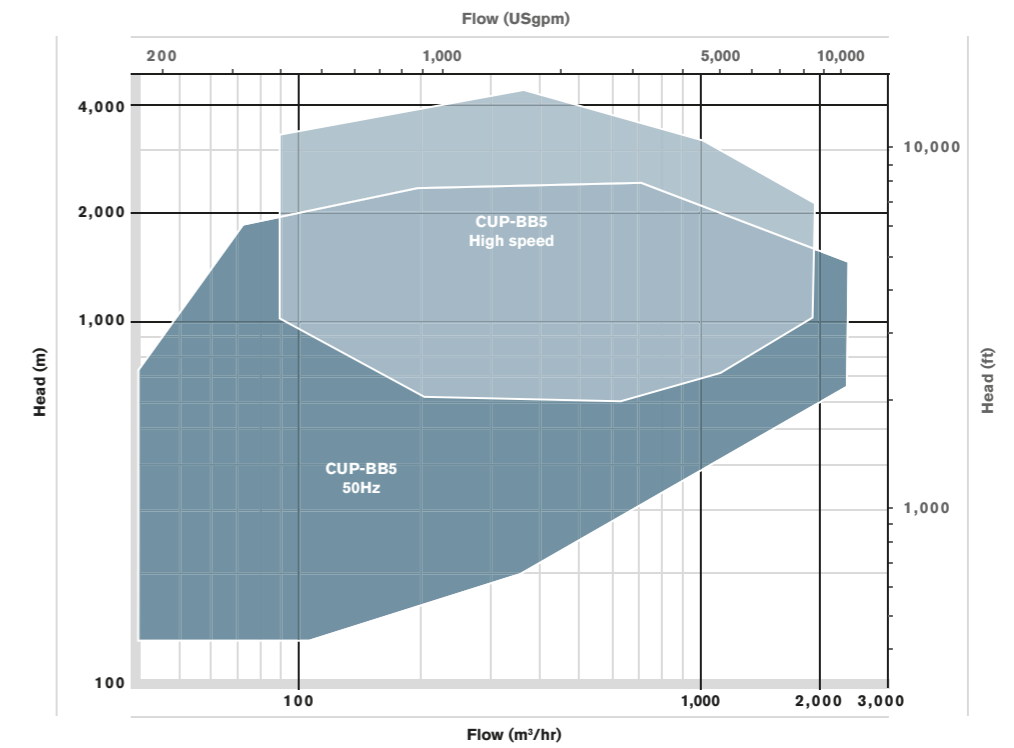

60HZ RANGE COVERAGE CHART

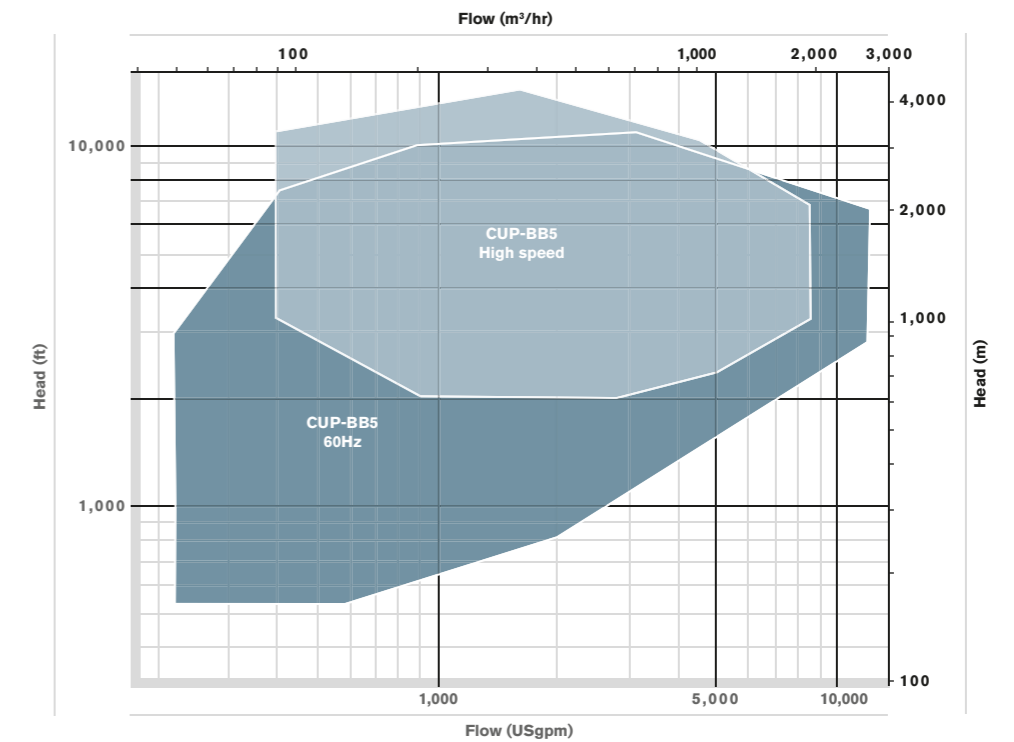

These charts cover the CUP-BB5 standard pump range. Other engineering designs exist for extreme applications

GLOBAL AFTERMARKET CAPABILITY BEST IN SERVICE & RESPONSE

Our customer focused aftermarket organisation is positioned to provide comprehensive care for our varied and diverse product lines. Heritage and obsolete products benefit from the same level of attention and expertise ensuring that reliability and availability is maximised irrespective of a pump's length of service.

GENUINE HIGH QUALITY

Original or upgraded specification spare parts, coupled with full engineering design capability, enables longevity of reliable operation. Highly skilled and experienced service engineers ensure accuracy in build and optimised performance.

SERVICE SOLUTIONS

Celeros Flow Technology is committed to supporting our installed base wherever it may be. Depending on your location we will provide either direct service support or support via our local authorised service partners. Whichever option is provided, you can be assured of the best attention from fully qualified and experienced engineers.

- Upgrades & re-rates
- Service & overhaul
- Installation & commissioning
- Technical support
- Inventory management
- 3rd party equipment

EASE OF MAINTENANCE

The simple construction of the CUP-BB5 pump offers ease of maintenance and reliability. The rotating element is housed within a horizontal, axially split inner case, subsequently contained in an outer barrel case. This can be easily removed without disturbance to main pipework. A complete rotor change-out can be completed in under eight hours. To further reduce overhaul time we can provide spare cartridges offering like for like performance or re-rates.

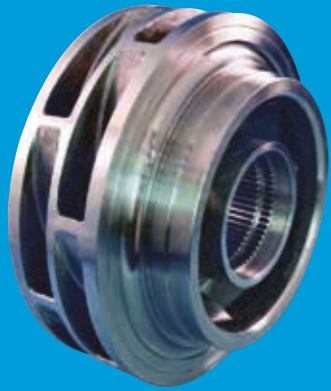

Parts & maintenance:
Any brand, any material, anytime.
Heritage products, upgrades & improvements

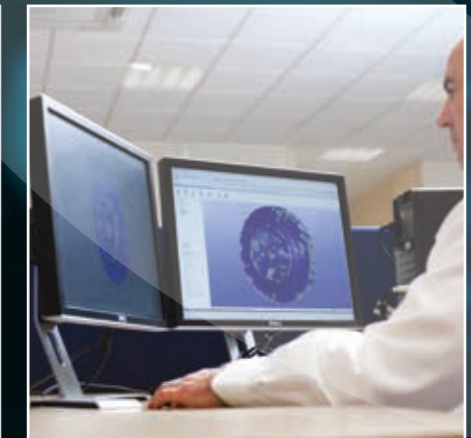
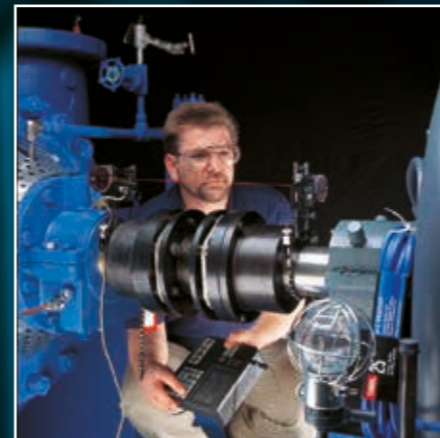

| SPEED
| EXCELLENCE
| PARTNERSHIP

CLYDEUNION®
PUMP

EUROPE

Annecy	P: +33 45 005 5600	E: cu.annecy@celerosft.com
Glasgow	P: +44 141 637 7141	E: cu.glasgow@celerosft.com

AMERICAS

Baton Rouge, LA	P: +1 225 775 2660	E: cu.batonrouge@celerosft.com
Battle Creek, MI	P: +1 269 966 4600	E: cu.battlecreek@celerosft.com
Burlington, ON	P: +1 905 315 3800	E: cu.burlington@celerosft.com
Calgary, AB	P: +1 403 236 8725	E: cu.calgary@celerosft.com
Los Angeles, CA	P: +1 562 622 2380	E: cu.downey@celerosft.com
Houston, TX	P: +1 281 372 5040	E: cu.houston@celerosft.com

ASIA

Beijing	P: +86 10 5926-7000	E: cu.beijing@celerosft.com
New Delhi	P: +91 120 4640 400	E: cu.newdelhi@celerosft.com
Shanghai	P: +86 21 2208 5888	E: cu.shanghai@celerosft.com
Singapore	P: +65 62 76 7117	E: cu.singapore@celerosft.com

Middle East/Africa

Abu Dhabi	P: +971 2 408 1900	E: abudhabi.sc@celerosft.com
Dubai	P: +971 (0)4-5289555	E: abudhabi.sc@celerosft.com

Celeros Flow Technology reserves the right to incorporate our latest design and material changes without notice or obligation. Design features, materials of construction, and dimensional data, as described in this bulletin, are provided for your information only and should not be relied upon unless confirmed in writing. Please contact your local sales representative for product availability in your region. For more information, visit www.celerosft.com.

CUP_BB5_225_PB_A4_ Version 05/2021 Issued 05/2021
COPYRIGHT © 2021 CELEROS, Inc.